

## ACDBA240-HF

**Reverse Voltage: 40 Volts**  
**Forward Current: 2.0 Amp**  
**RoHS Device**  
**Halogen free**

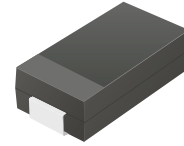

### Features

- Low profile package.
- Ideal for automated placement.
- Guard Ring for over voltage protection.
- Low forward voltage drop.
- Comply with AEC-Q101

### Mechanical data

- Case: DO-214AC / SMA, molded plastic.
- Epoxy: UL flammability classification rate 94V-0 .
- Terminals: Lead free plating (Tin finish).  
Solderable per MIL-STD-202, Method 208.
- Polarity: Indicated by cathode band.
- Weight: 0.062 grams(approx.).

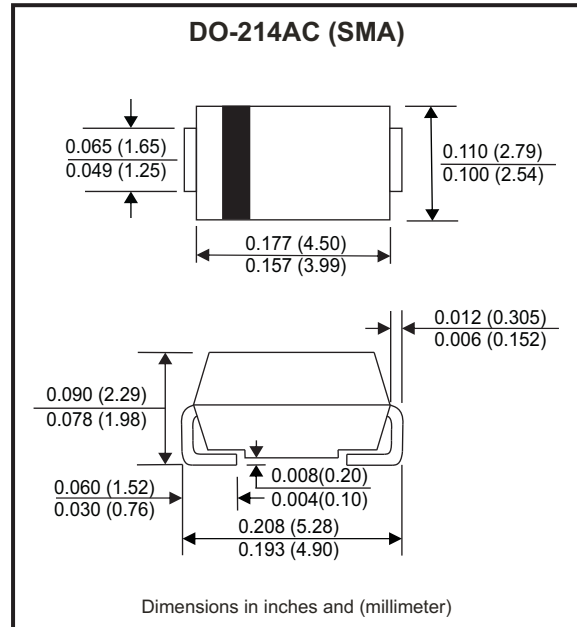

### Circuit diagram



### Maximum Ratings (at TA=25°C unless otherwise noted)

Parameter	Conditions	Symbol	MIN.	TYP.	MAX.	Unit
Repetitive peak reverse voltage		$V_{RRM}$			40	V
DC blocking voltage		$V_{DC}$			40	V
RMS voltage		$V_{RMS}$			28	V
Average forward rectified current		$I_F$			2	A
Peak forward surge current	8.3ms single half sine-wave superimposed on rate load (JEDEC method)	$I_{FSM}$			50	A
Operating Temperature range		$T_J$	-55		+125	°C
Storage temperature range		$T_{STG}$	-55		+150	°C

### Electrical Characteristics (at TA=25°C unless otherwise noted)

Parameter	Conditions	Symbol	MIN.	TYP.	MAX.	Unit
Instantaneous forward voltage	$I_F = 2A, T_A = 25^\circ C$	$V_F$			0.5	V
Reverse Current	$V_R = V_{RRM}, T_A = 25^\circ C$	$I_R$			0.5	mA
	$V_R = V_{RRM}, T_A = 100^\circ C$	$I_R$			15	mA
Junction capacitance (Note 1)	f=1MHz and applied 4V DC reverse Voltage	$C_J$		125		pF
Thermal Resistance	Junction to case	$R_{\theta JC}$		40		°C/W

Note: 1. Measured at 1.0MHZ and applied reverse voltage of 4.0V DC.

Company reserves the right to improve product design , functions and reliability without notice.

REV: A

## Rating and Characteristics Curvers (ACDBA240-HF)

Fig.1 - Typical Forward Current Derating Curve

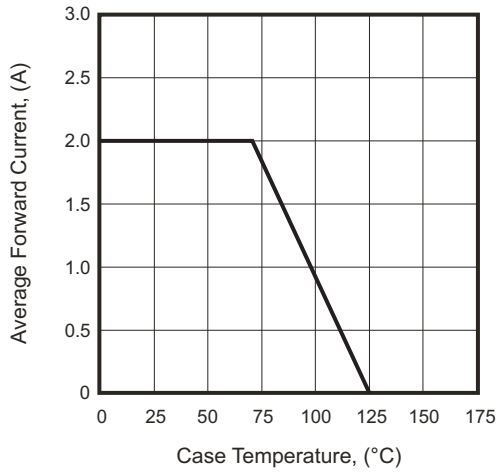

Fig.2 - Typical Forward Characteristics

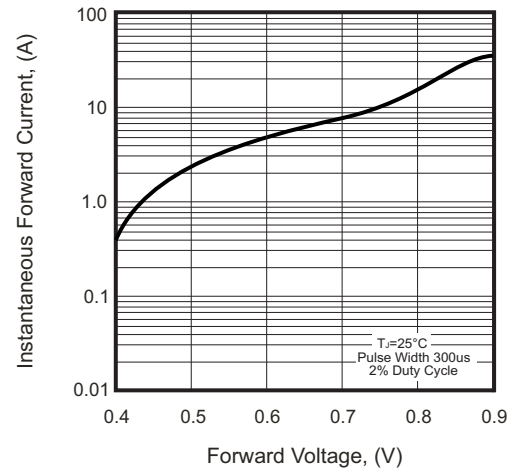

Fig.3 - Maximum Non-repetitive Forward Surge Current

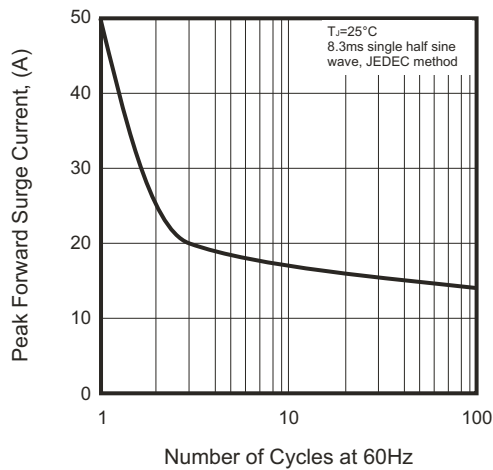

Fig.4 - Typical Reverse Characteristics

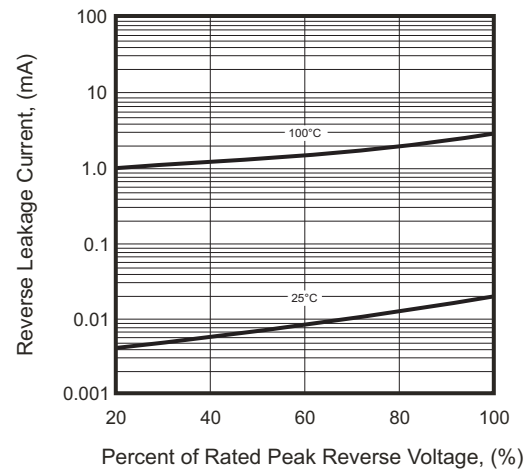
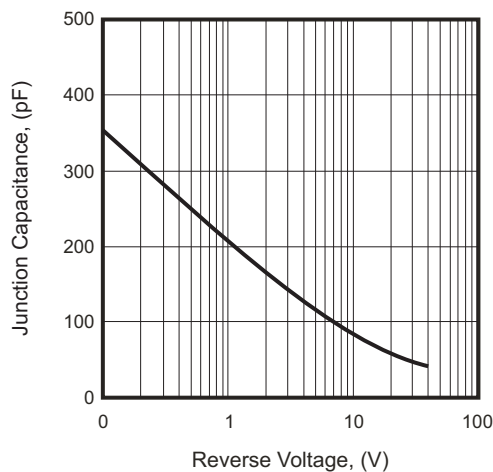

Fig.5 - Typical Junction Capacitance



Company reserves the right to improve product design, functions and reliability without notice.

REV: A

## Reel Taping Specification



DO-214AC (SMA)	SYMBOL	A	B	C	d	D	D <sub>1</sub>	D <sub>2</sub>
	(mm)	2.90 MAX.	5.90 MAX.	2.66 MAX.	1.50 ± 0.10	330 ± 2.00	50 MIN.	13.50 ± 1.00
	(inch)	0.114 MAX.	0.232 MAX.	0.105 MAX.	0.059 ± 0.004	13.00 ± 0.079	1.969 MIN.	0.531 ± 0.039

DO-214AC (SMA)	SYMBOL	E	F	P	P <sub>0</sub>	P <sub>1</sub>	W	W <sub>1</sub>
	(mm)	1.75 ± 0.10	5.50 ± 0.05	4.00 ± 0.10	4.00 ± 0.10	2.00 ± 0.05	12.00 ± 0.30	18.40 MAX.
	(inch)	0.069 ± 0.004	0.217 ± 0.002	0.157 ± 0.004	0.157 ± 0.004	0.079 ± 0.002	0.472 ± 0.012	0.724 MAX.

Company reserves the right to improve product design, functions and reliability without notice.

REV: A

## Marking Code

Part Number	Marking Code
ACDBA240-HF	240



**xxx = Product type marking code**

## Suggested PAD Layout

SIZE	DO-214AC (SMA)	
	(mm)	(inch)
A	1.70	0.067
B	2.50	0.098
C	1.50	0.059
D	4.00	0.157
E	6.50	0.256

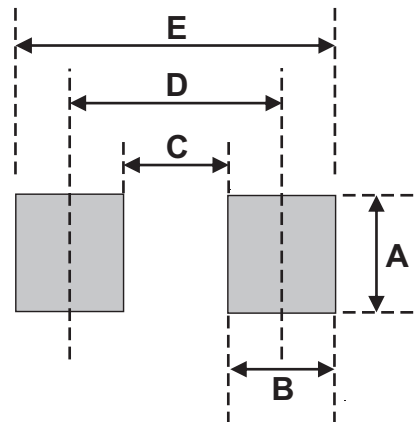

Note:

1. The pad layout is for reference purposes only.

## Standard Packaging

Case Type	REEL PACK	
	REEL ( pcs )	Reel Size (inch)
DO-214AC (SMA)	5,000	13