

ABAS16W-HF

RoHS Device
Halogen Free

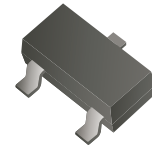

Features

- Fast switching speed.
- High conductance.
- For general purpose switching applications.
- Surface mount package ideally suited for automatic insertion.
- AEC-Q101 Qualified.

Mechanical data

- Case: SOT-323, molded plastic.
- Mounting position: Any.

Circuit Diagram

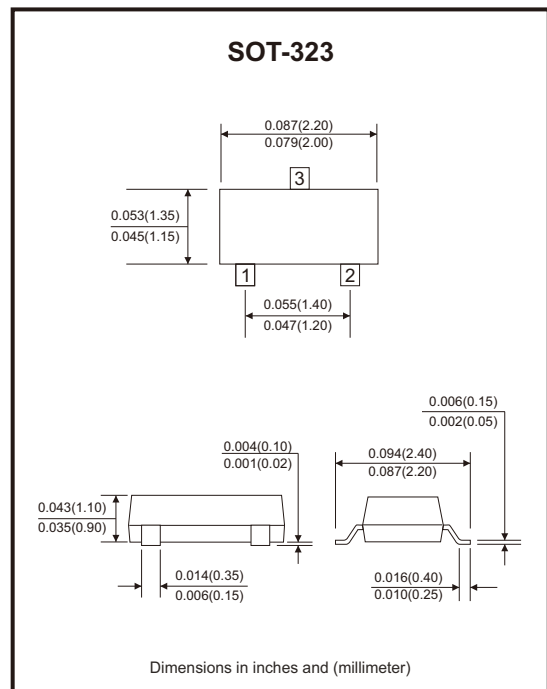
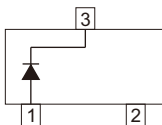

Maximum Ratings (at TA=25°C unless otherwise noted)

Parameter	Symbol	Value	Unit
Non-repetitive peak reverse voltage	V_{RM}	100	V
Peak repetitive reverse voltage	V_{RRM}	75	V
Working peak reverse voltage	V_{RWM}	75	V
DC blocking voltage	V_R	75	V
RMS reverse voltage	V_{RMS}	53	V
Average rectified output current	I_O	150	mA
Non-repetitive peak forward surge current @ t = 8.3ms	I_{FSM}	2	A
Power dissipation	P_D	200	mW
Thermal resistance junction to ambient air	$R_{\theta JA}$	625	°C/W
Operating and storage temperature range	T_J, T_{STG}	-65 to +150	°C

Electrical Characteristics (at TA=25°C unless otherwise noted)

Parameter	Conditions	Symbol	Min.	Typ.	Max.	Unit
Reverse breakdown voltage	$I_R = 1\mu A$	V_{BR}	75			V
Reverse current	$V_R = 20V$	I_R			25	nA
	$V_R = 75V$				1	μA
Forward voltage	$I_F = 1mA$	V_F			715	mV
	$I_F = 10mA$				855	
	$I_F = 50mA$				1000	
	$I_F = 150mA$				1250	
Diode capacitance	$V_R = 0V, f = 1MHz$	C_J			2	pF
Reverse recovery time	$I_F = I_R = 10mA, R_L = 100\Omega$	t_{rr}			4	nS

Typical Rating and Characteristic Curves (ABAS16W-HF)

Fig.1 - Forward Characteristics

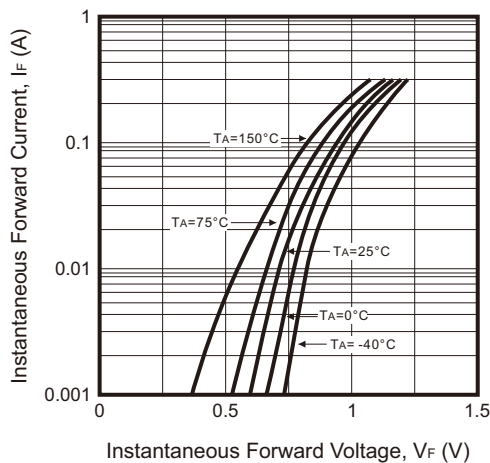

Fig.2 - Typical Reverse Characteristics

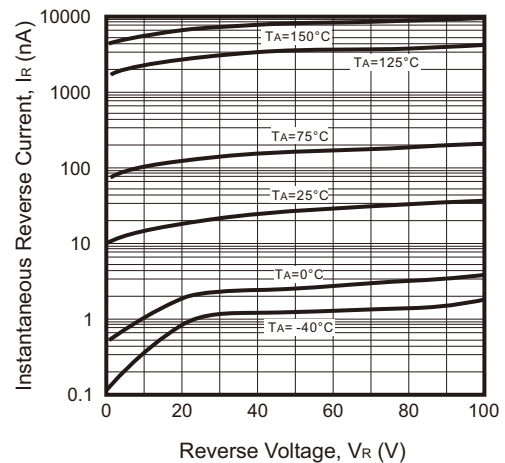

Fig.3 - Typical Capacitance vs. Reverse Voltage

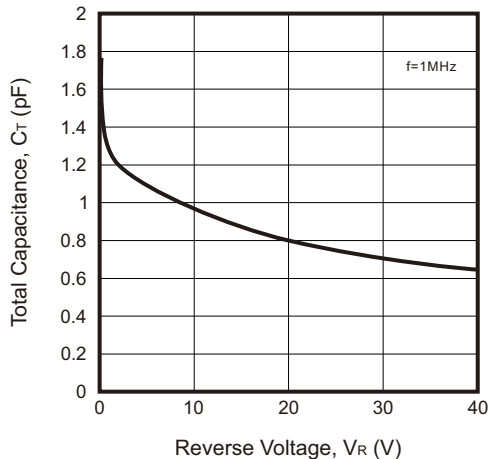
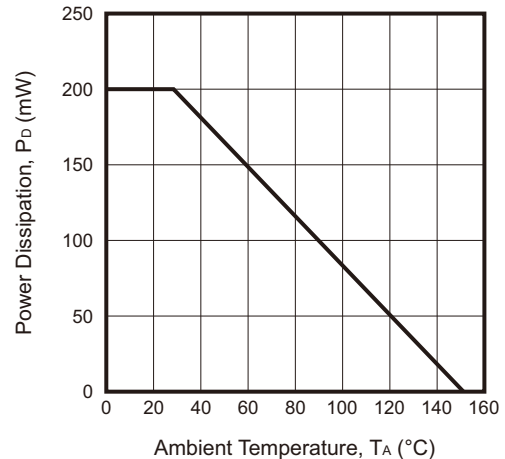
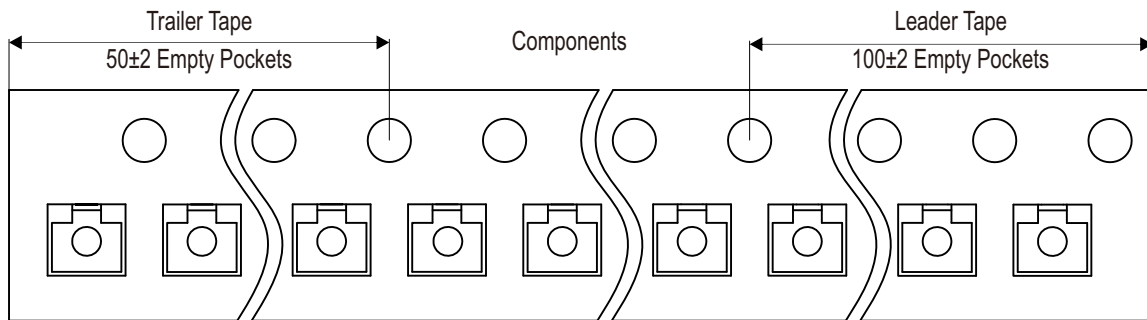
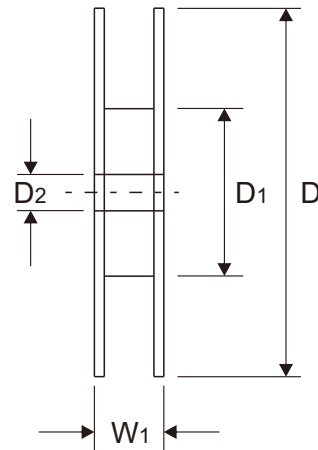
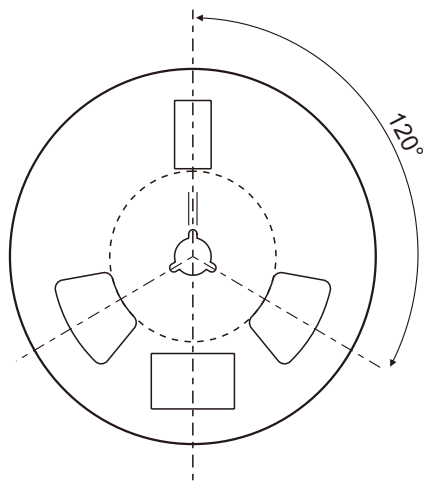
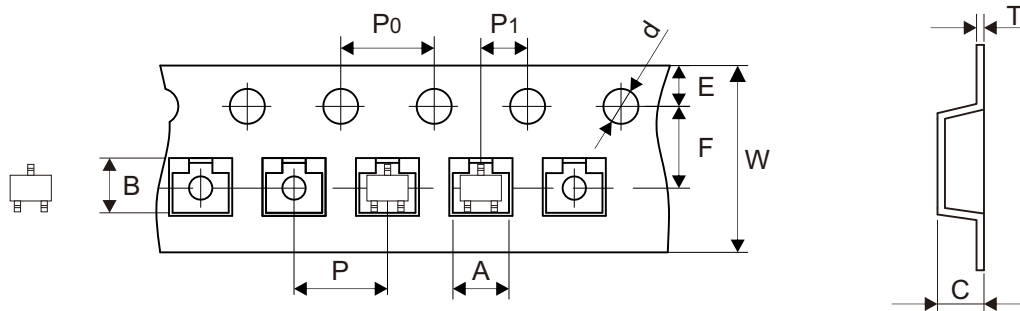

Fig.4 - Power Derating Curve, Total Package



Reel Taping Specification



SOT-323	SYMBOL	A	B	C	d	D	D1	D2
	(mm)	2.25 ± 0.10	2.55 ± 0.10	1.19 ± 0.10	1.50 ± 0.10	178.00 ± 1.00	54.00 ± 0.50	13.00 ± 0.50
	(inch)	0.089 ± 0.004	0.100 ± 0.004	0.047 ± 0.004	0.059 ± 0.004	7.008 ± 0.039	2.126 ± 0.020	0.512 ± 0.020

SOT-323	SYMBOL	E	F	P	P0	P1	T	W	W1
	(mm)	1.75 ± 0.10	3.50 ± 0.10	4.00 ± 0.10	4.00 ± 0.10	2.00 ± 0.05	0.22 ± 0.02	8.00 + 0.30 - 0.10	12.50 ± 1.00
	(inch)	0.069 ± 0.004	0.138 ± 0.004	0.157 ± 0.004	0.157 ± 0.004	0.079 ± 0.002	0.009 ± 0.001	0.315 + 0.012 - 0.004	0.492 ± 0.039

Marking Code

Part Number	Marking Code
ABAS16W-HF	A2

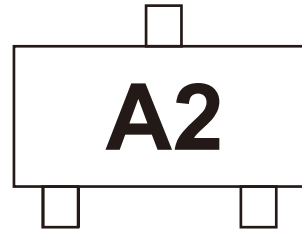

Suggested P.C.B. PAD Layout

SIZE	SOT-323	
	(mm)	(inch)
A	0.90	0.035
B	0.70	0.028
C	0.65	0.026
D	1.90	0.075

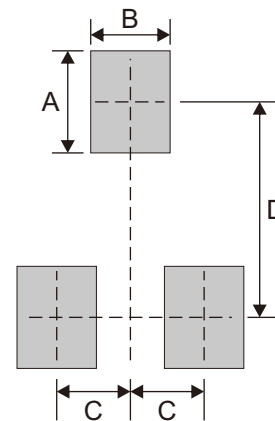

Standard Packaging

Case Type	REEL PACK	
	REEL (pcs)	Reel Size (inch)
SOT-323	3,000	7