

## A2N7002HW-HF

**N-Channel  
RoHS Device  
Halogen Free**

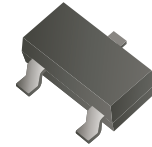

### Features

- Low on-resistance.
- ESD protected gate up to 2KV HBM.
- High-speed switching.
- Drive circuits can be simple.
- Parallel use is easy.
- AEC-Q101 Qualified.

### Mechanical data

- Case: SOT-323, molded plastic.
- Molding compound, UL flammability classification rating 94V-0.
- Terminals: Matte tin plated leads, solderable per MIL-STD-202, method 208.

### Circuit Diagram

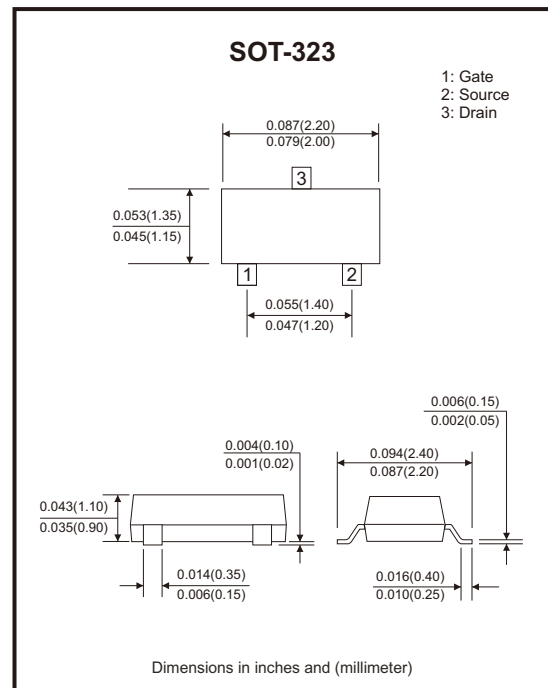
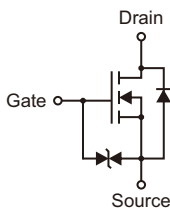

### Maximum Rating (at $T_A=25^{\circ}\text{C}$ unless otherwise noted)

Parameter	Symbol	Value	Unit
Drain-source voltage	$V_{DSS}$	60	V
Gate-source voltage	$V_{GSS}$	$\pm 20$	V
Continuous drain current	$I_D$	300	mA
Pulsed drain current (Note 4) $t_p = 10\mu\text{s}$	$I_{DM}$	2000	mA
Power dissipation	$P_D$	0.25	W
Thermal resistance junction to ambient air	$R_{\theta JA}$	500	$^{\circ}\text{C/W}$
Thermal resistance junction to lead	$R_{\theta JL}$	313	$^{\circ}\text{C/W}$
Thermal resistance junction to case	$R_{\theta JC}$	261	$^{\circ}\text{C/W}$
Operating junction temperature range	$T_J$	-55 to +150	$^{\circ}\text{C}$
Storage temperature range	$T_{STG}$	-55 to +150	$^{\circ}\text{C}$

Company reserves the right to improve product design, functions and reliability without notice.

REV:A

## Electrical Characteristics (at $T_A=25^\circ\text{C}$ unless otherwise noted)

Parameter	Symbol	Conditions	Min	Typ	Max	Unit
<b>Off Characteristics</b>						
Drain-source breakdown voltage	$V_{DSS}$	$V_{GS} = 0V, I_D = 250\mu A$	60			V
Drain-source leakage current	$I_{DSS}$	$V_{DS} = 60V, V_{GS} = 0V$			1	$\mu A$
Gate-body leakage	$I_{GSS}$	$V_{GS} = \pm 20V, V_{DS} = 0V$			$\pm 10$	$\mu A$
<b>On Characteristics (Note 2)</b>						
Static drain-source on resistance	$R_{DS(ON)}$	$V_{GS} = 5V, I_D = 0.05A$ $V_{GS} = 10V, I_D = 0.5A$		1.5 1.45	3 2.5	$\Omega$
Gate threshold voltage	$V_{GS(th)}$	$V_{DS} = V_{GS}, I_D = 250\mu A$	1	1.5	2.5	V
<b>Dynamic Characteristics (Note 3)</b>						
Input capacitance	$C_{iss}$	$V_{GS} = 0V, V_{DS} = 20V, f = 1MHz$		41		pF
Output capacitance	$C_{oss}$			15		
Reverse transfer capacitance	$C_{rss}$			4		
<b>Switching Characteristics (Note 3)</b>						
Turn-on delay time	$t_{d(on)}$	$V_{DD} = 30V, I_D = 0.2A,$ $V_{GS} = 10V, R_G = 25\Omega,$ $R_L = 150\Omega$		6		nS
Turn-on rise time	$t_r$			5		
Turn-off delay time	$t_{d(off)}$			25		
Turn-off fall time	$t_f$			15		
<b>Drain-Source Diode Characteristics</b>						
Diode forward voltage (Note 1)	$V_{SD}$	$I_S = 0.3A, V_{GS} = 0V$		0.85	1.2	V
Diode continuous forward current	$I_S$	$T_C = 25^\circ\text{C}$			0.3	A

- Notes: 1. Surface mounted on FR4 board,  $t \leq 10$  sec.  
 2. Pulse width  $\leq 300\mu s$ , duty cycle  $\leq 2\%$ .  
 3. Guaranteed by design, not subject to production.  
 4. Pulse width limited by maximum junction temperature.

## Rating and Characteristic Curves (A2N7002HW-HF)

Fig.1 - On-Region Characteristics

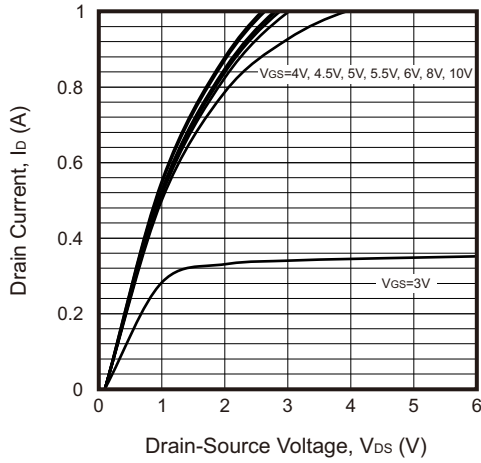

Fig.2 - On-Resistance vs. Drain Current and Gate Voltage

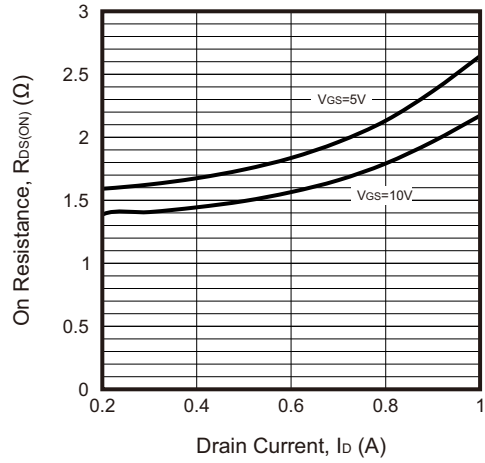

Fig.3 - On-Resistance vs. Gate-Source Voltage

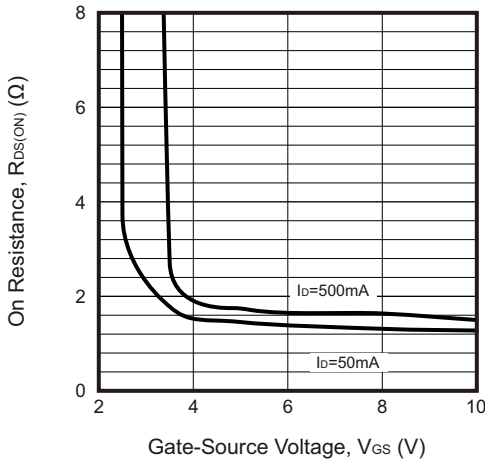

Fig.4 - Gate Voltage vs. Junction Temperature

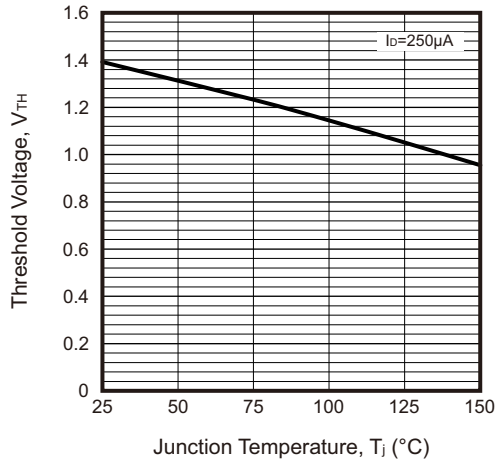

Fig.5 - On Resistance vs. Junction Temperature

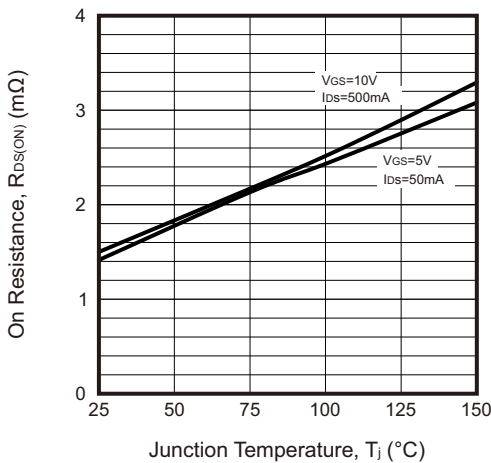
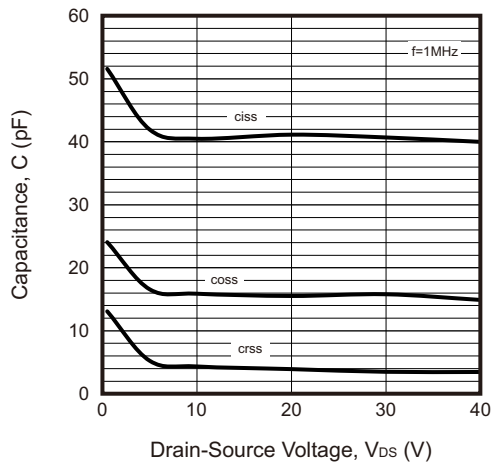

Fig.6 - Capacitance Characteristics



Company reserves the right to improve product design, functions and reliability without notice.

REV:A

## Reel Taping Specification

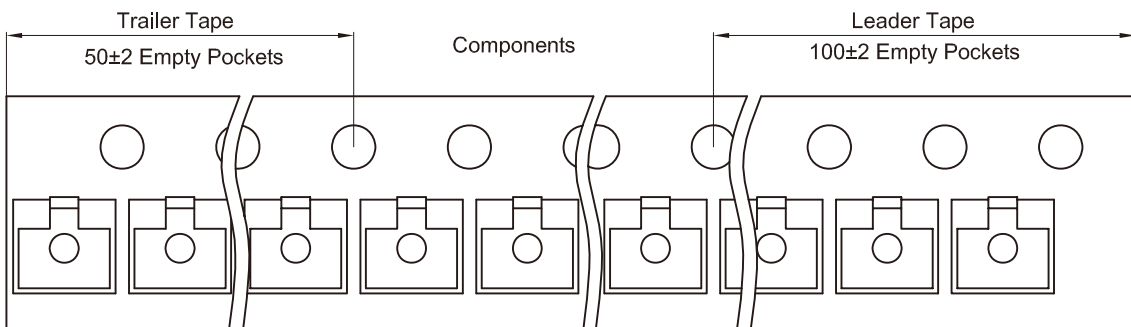
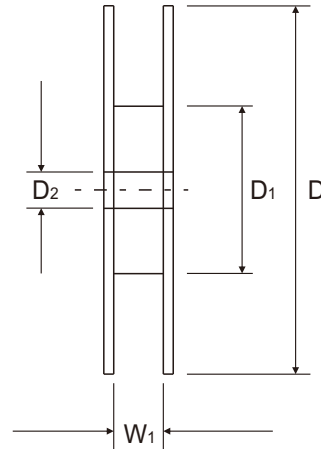
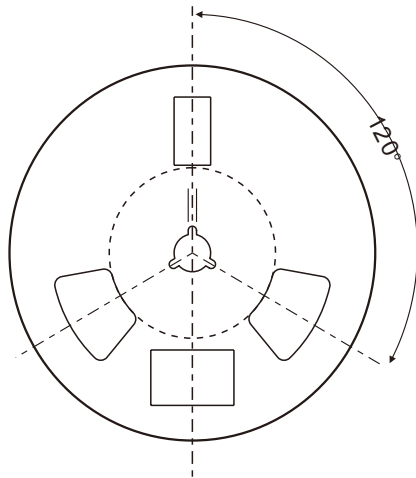
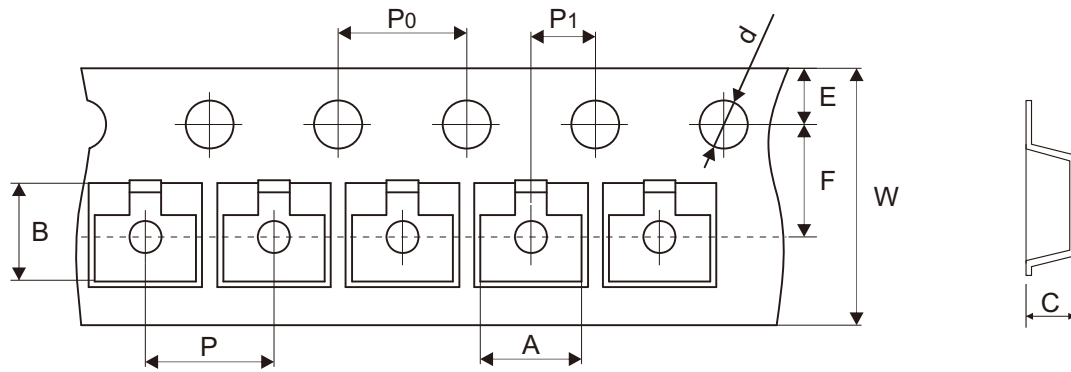

SOT-323	SYMBOL	A	B	C	d	D	D1	D2
	(mm)	2.25 ± 0.10	2.55 ± 0.10	1.20 ± 0.10	1.50 ± 0.10	178.00 ± 1.00	54.00 ± 0.50	13.00 ± 0.50
	(inch)	0.089 ± 0.004	0.100 ± 0.004	0.047 ± 0.004	0.059 ± 0.004	7.008 ± 0.039	2.126 ± 0.020	0.512 ± 0.020

SOT-323	SYMBOL	E	F	P	P0	P1	W	W1
	(mm)	1.75 ± 0.10	3.50 ± 0.05	4.00 ± 0.10	4.00 ± 0.10	2.00 ± 0.05	8.00 + 0.30 - 0.10	9.50 ± 1.00
	(inch)	0.069 ± 0.004	0.138 ± 0.002	0.157 ± 0.004	0.157 ± 0.004	0.079 ± 0.002	0.315 + 0.012 - 0.004	0.374 ± 0.039

Company reserves the right to improve product design, functions and reliability without notice.

REV:A

## Marking Code

Part Number	Marking Code
A2N7002HW-HF	RKS

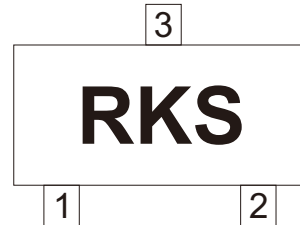

## Suggested PAD Layout

SIZE	SOT-323	
	(mm)	(inch)
A	0.90	0.035
B	0.70	0.028
C	1.30	0.051
D	1.90	0.075

Note: 1. The pad layout is for reference purposes only.

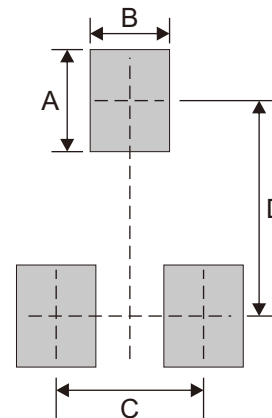

## Standard Packaging

Case Type	REEL PACK	
	REEL (pcs)	Reel Size (inch)
SOT-323	3,000	7