

ACMS40N06D-HF

**N-Channel
RoHS Device
Halogen Free**

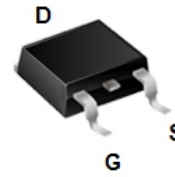

Features

- Advanced shielded-gate tench technology.
- Super low on-resistance.
- Fast switching speed.
- Excellent C_{dv}/dt effect decline.
- AEC-Q101 Qualified.

Mechanical data

- Case: TO-252, molded plastic.
- Molding compound: UL flammability classification rating 94V-0.
- Terminals: Matte tin-plated leads, solderability-per MIL-STD-202, method 208.

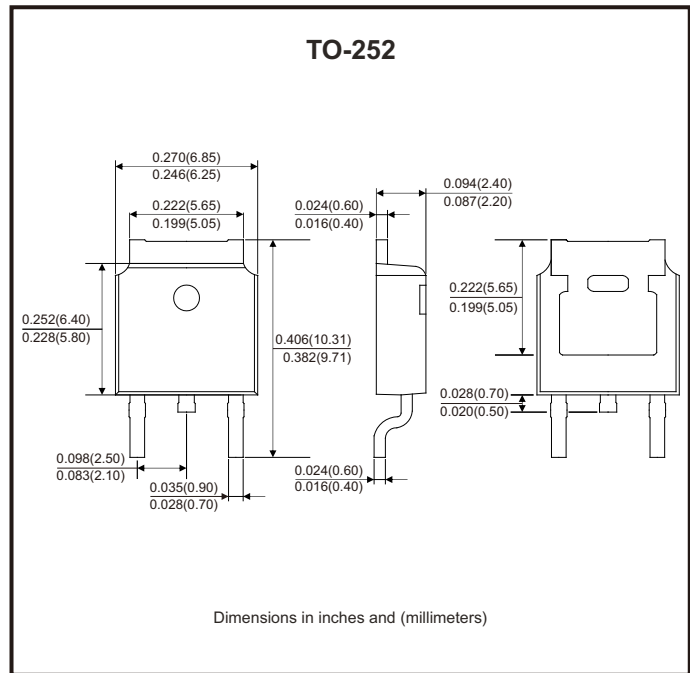

Circuit Diagram

- G : Gate
- S : Source
- D : Drain

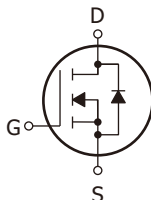

Maximum Ratings (at TA=25°C unless otherwise noted)

Parameter	Symbol	Value	Unit
Drain-source voltage	V_{DS}	60	V
Gate-source voltage	V_{GS}	±20	V
Continuous drain current (Tc=25°C)	I_D	40	A
Continuous drain current (Tc=100°C)	I_D	33	
Pulsed drain current (tp= 10µs, Tc=25°C)	I_{DM}	270	A
Single pulse avalanche energy (Note 3)	E_{AS}	53	mJ
Power dissipation (Tc=25°C)	P_D	37	W
Operating junction temperature range	T_J	-55 to +150	°C
Storage temperature range	T_{STG}	-55 to +150	°C

Thermal Characteristics

Parameter	Symbol	Min	Typ	Max	Unit
Thermal resistance junction to case	$R_{\theta JC}$		2.4	3.4	°C/W
Thermal resistance junction to air (Note 1)	$R_{\theta JA}$		27	35	°C/W

Electrical Characteristics (at $T_A=25^\circ\text{C}$ unless otherwise noted)

Parameter	Symbol	Conditions	Min	Typ	Max	Unit
Static Characteristics						
Drain-source breakdown voltage	V_{DS}	$V_{GS} = 0V, I_D = 250\mu A$	60			V
Zero gate voltage drain current	I_{DSS}	$V_{DS} = 48V, V_{GS} = 0V$			1	μA
Gate-body leakage current	I_{GSS}	$V_{GS} = \pm 20V, V_{DS} = 0V$			± 100	nA
On Characteristics						
Static drain-source on-resistance (Note 2)	$R_{DS(on)}$	$V_{GS} = 10V, I_D = 20A$		7.3	8.5	m Ω
	$R_{DS(on)}$	$V_{GS} = 4.5V, I_D = 15A$		10.9	14.5	m Ω
Gate threshold voltage	$V_{GS(th)}$	$V_{DS} = V_{GS}, I_D = 250\mu A$	1	1.72	2.5	V
Gate resistance	R_G	$V_{GS} = 0V, f = 1MHz$		2.5		Ω
Dynamic Characteristics						
Input capacitance	C_{iss}	$V_{GS} = 0V, V_{DS} = 15V, f = 1MHz$		1430		pF
Output capacitance	C_{oss}			724		
Reverse transfer capacitance	C_{rss}			98.9		
Switching Characteristics						
Turn-on delay time	$t_{d(on)}$	$V_{DD} = 30V, V_{GS} = 15V$ $R_G = 3.3\Omega, I_D = 20A$		7		ns
Turn-on rise time	t_r			46		
Turn-off delay time	$t_{d(off)}$			30		
Turn-off fall time	t_f			40		
Total gate charge	Q_g	$V_{DD} = 15V, V_{GS} = 10V, I_D = 20A$		23.8		nC
Gate to source charge	Q_{gs}			4		
Gate to drain (miller) charge	Q_{gd}			5.4		
Source-Drain Diode Characteristics						
Diode forward voltage (Note 2)	V_{SD}	$I_{SD} = 40A, V_{GS} = 0V$		0.95	1.2	V
Reverse recovery time	t_{rr}	$I_{SD} = 20A, V_{GS} = 0V, di/dt = 100A/\mu s$		37		ns
Reverse recovery charge	Q_{rr}			31		nC

- Notes: 1. The data tested by surface mounted on a 1 inch² FR-4 board with 2OZ copper.
 2. The data tested by pulsed, pulse width $\leq 300\mu s$, duty cycle $\leq 2\%$.
 3. The EAS data shows Max. rating. The test condition is $V_{DD}=25V, V_{GS}=10V, L=10mH$.

Typical Rating and Characteristic Curves (ACMS40N06D-HF)

Fig.1 - Power Dissipation

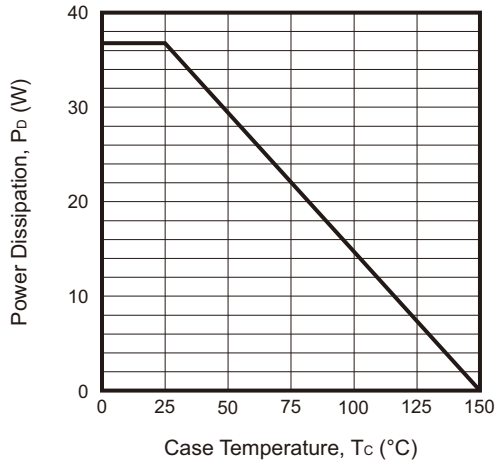

Fig.2 - Drain Current

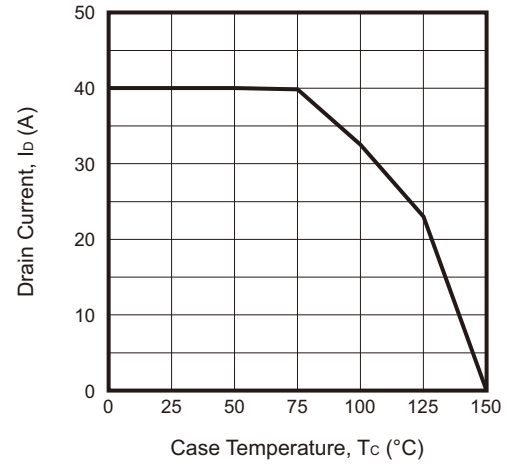

Fig.3 - Typical Output Characteristics

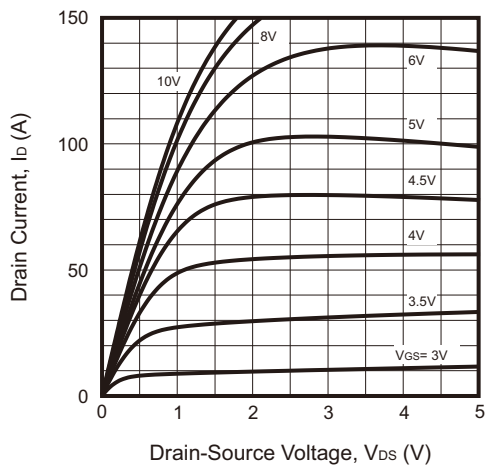

Fig.4 - On-Resistance vs. Drain Current and Gate Voltage

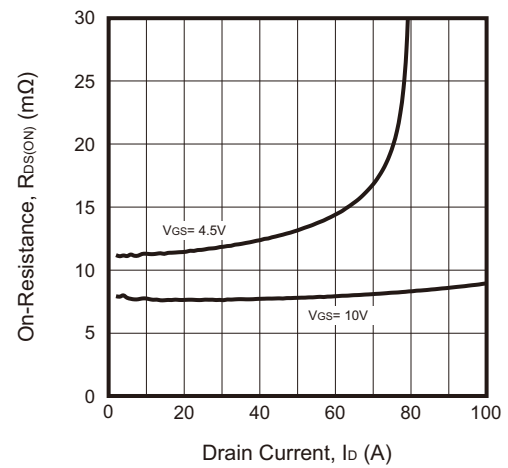

Fig.5 - On-Resistance vs. Gate-Source Voltage

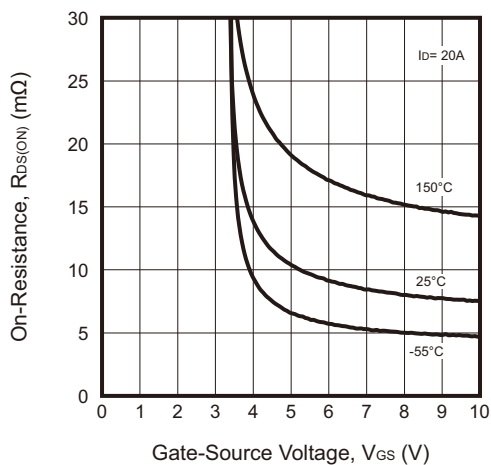
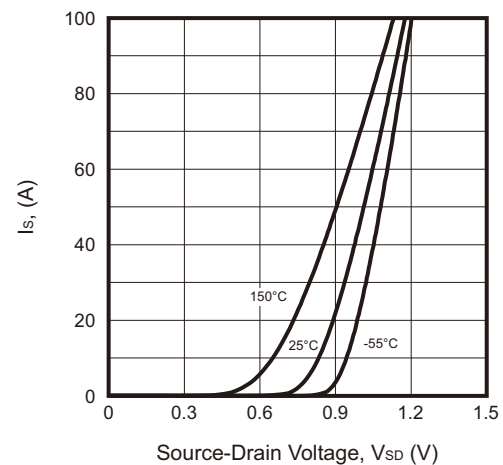

Fig.6 - Body-Diode Characteristics



Typical Rating and Characteristic Curves (ACMS40N06D-HF)

Fig.7 - Normalized On-Resistance vs. Junction Temperature

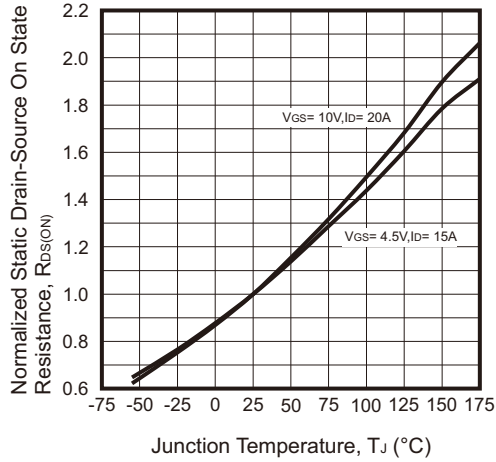

Fig.8 - Transfer Characteristics

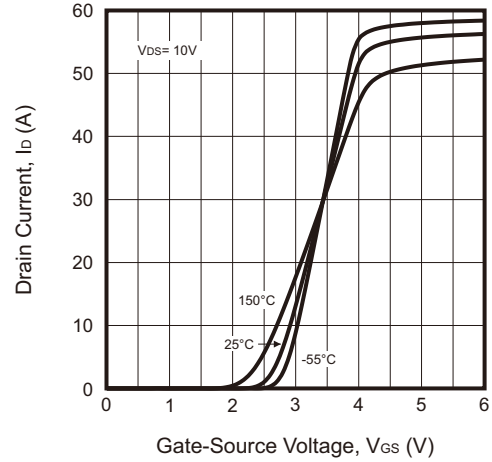

Fig.9 - Capacitance Characteristics

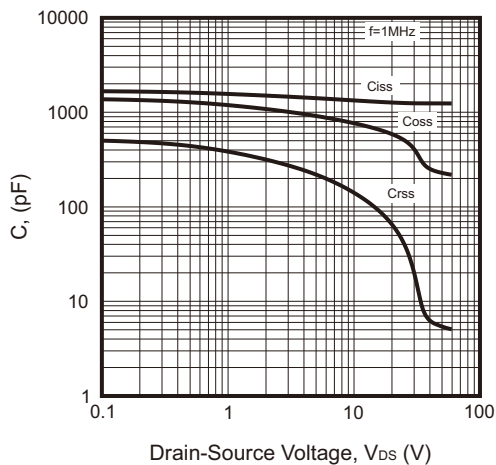

Fig.10 - Gate-Charge Characteristics

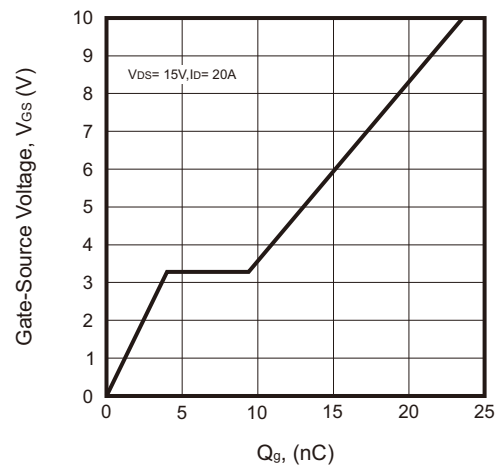

Fig.11 - Normalized Breakdown Voltage vs. Junction Temperature

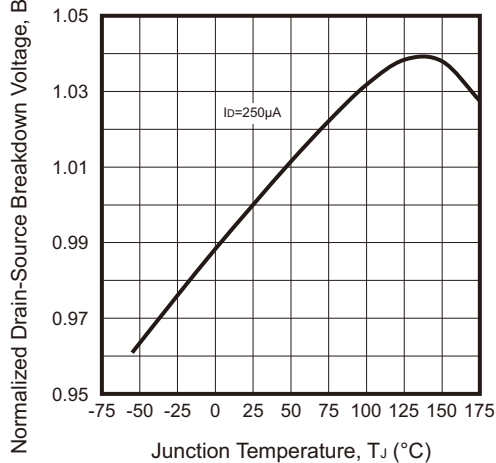
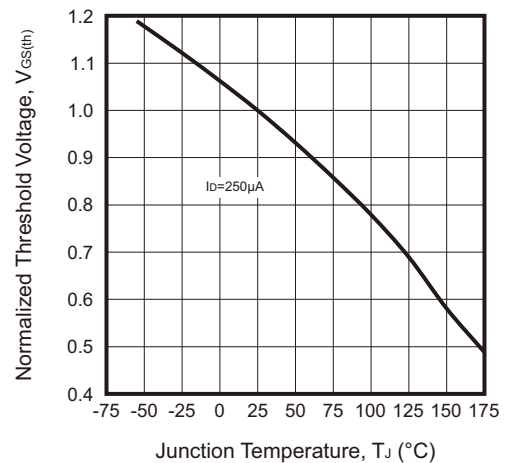
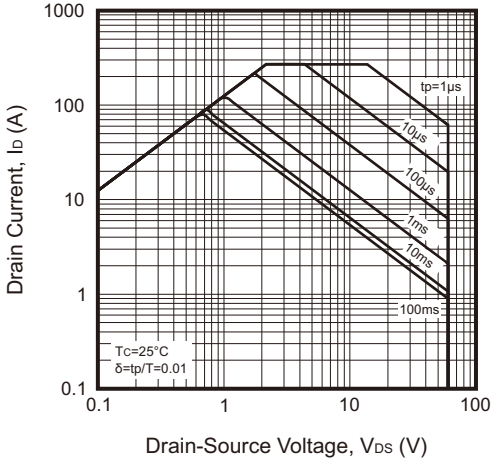

Fig.12 - Normalized V_GS(th) vs. Junction Temperature



Typical Rating and Characteristic Curves (ACMS40N06D-HF)

Fig.13 - Safe Operating Area



Reel Taping Specification

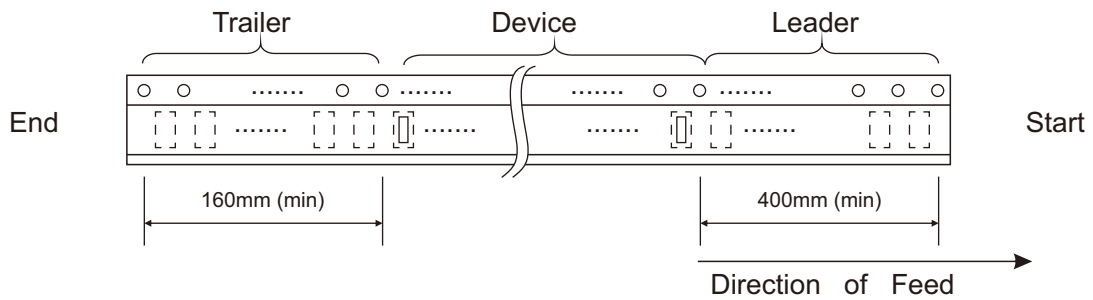
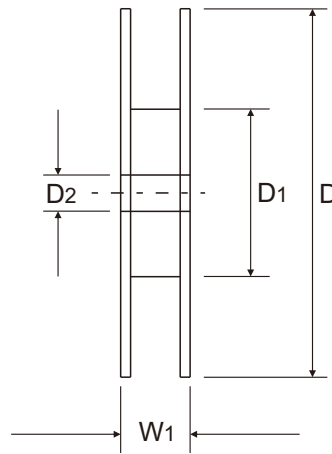
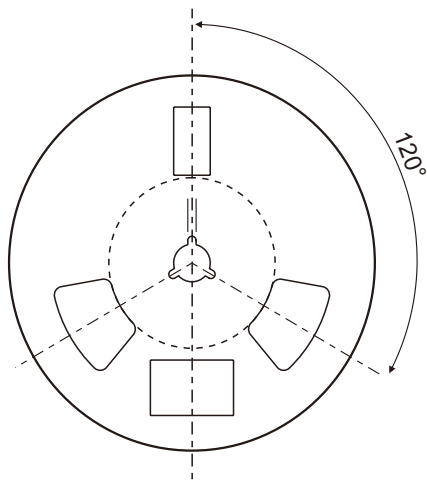
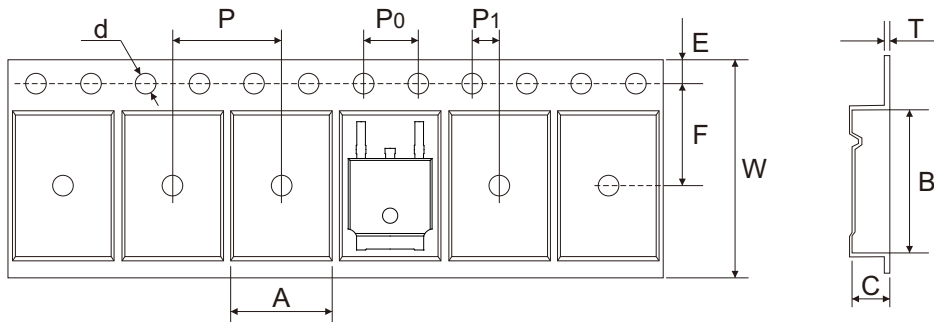

TO-252	SYMBOL	A	B	C	d	D	D1	D2
	(mm)	6.90 ± 0.10	10.50 ± 0.10	2.70 ± 0.10	1.50 + 0.25	330 ± 1.00	100 ± 1.00	13.00 ± 0.20
	(inch)	0.272 ± 0.004	0.413 ± 0.004	0.106 ± 0.004	0.059 + 0.010	12.992 ± 0.039	3.937 ± 0.039	0.512 ± 0.008

TO-252	SYMBOL	E	F	P	P0	P1	T	W	W1
	(mm)	1.75 ± 0.10	7.50 ± 0.10	8.00 ± 0.10	4.00 ± 0.10	2.00 ± 0.10	0.30 ± 0.10	16.00 + 0.30 - 0.20	21.00 ± 0.30
	(inch)	0.069 ± 0.004	0.295 ± 0.004	0.315 ± 0.004	0.157 ± 0.004	0.079 ± 0.004	0.012 ± 0.004	0.630 + 0.012 - 0.008	0.827 ± 0.012

Marking Code

Part Number	Marking Code
ACMS40N06D-HF	085N06TD

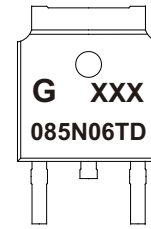

XXX = Control code

Suggested P.C.B. PAD Layout

SIZE	TO-252	
	(mm)	(inch)
A	1.80	0.071
B	2.70	0.106
C	1.50	0.059
D	2.30	0.091
E	6.40	0.252
F	6.80	0.268

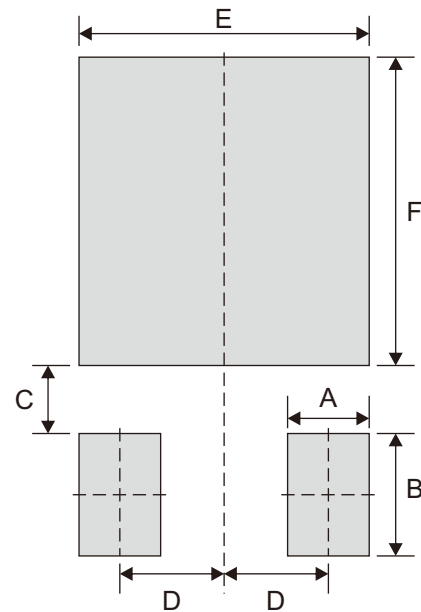

Standard Packaging

Case Type	REEL PACK	
	REEL (pcs)	Reel Size (inch)
TO-252	2,500	13