

ATV15C5V0-HF Thru. ATV15C441-HF

Working Peak Reverse Voltage: 5.0 to 440 Volts

Power Dissipation: 1500Watts

RoHS Device

Halogen Free



Features

- Glass passivated chip.
- 1500W peak pulse power capability with a 10/1000µs waveform, repetitive rate (duty cycle):0.01%
- Low leakage.
- Uni and Bidirectional unit.
- Excellent clamping capability.
- Very fast response time.
- Comply with AEC-Q101
- UL recognized file # E349157  Range: ATV15C5V0J(B) thru. ATV15C101J(B)

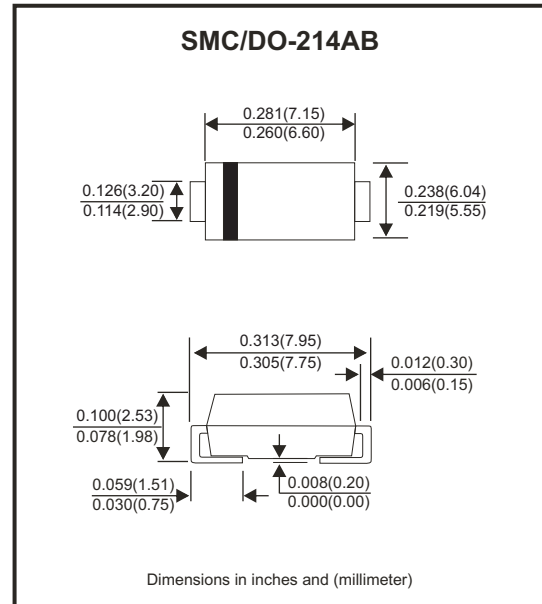

Mechanical Data

- Case: DO-214AB/SMC molded plastic.
- Epoxy: UL 94V-0 rate flame retardant
- Terminals: Solderable per MIL-STD-750, method 2026.
- Polarity: Color band denoted cathode end except bipolar.
- Weight: 0.230 gram (approx.)

Circuit Diagram



Maximum Ratings and Electrical Characteristics

Rating at 25°C ambient temperature unless otherwise specified.
Single phase, half wave, 60Hz, resistive or inductive load.
For capacitive load, derate current by 20%.

Characteristics	Symbol	Value	Units
Peak power dissipation with a 10/1000µs waveform (Note 1)	P _{PP}	1500	W
Peak pulse current with a 10/1000µs waveform (Note 1)	I _{PP}	See Next Table	A
Power dissipation on infinite heatsink at T _L =75°C	P _D	6.5	W
Peak forward surge current, 8.3ms single half sine-wave uni-directional only (Note 2)	I _{FSM}	200	A
Maximum instantaneous forward voltage at 100A for uni-directional only (Note 3)	V _F	3.5/5.0	V
Operation junction and storage temperature range	T _J , T _{STG}	-55 to +150	°C

Notes: 1. Non-repetitive current pulse, per Fig.5 and derated above T_A=25°C, per Fig.1
2. Measured on 8.3 ms single half sine-wave or equivalent square wave, duty cycle = 4 pulses per minute maximum.
3. V_F<3.5V for devices of V_{BR}<200V and V_F<5.0V for devices of V_{BR}>201V

Company reserves the right to improve product design , functions and reliability without notice.

REV: B

Ratings and Characteristics Curve (ATV15C5V0-HF Thru. ATV15C441-HF)

Fig.1 - Pulse Derating Curve

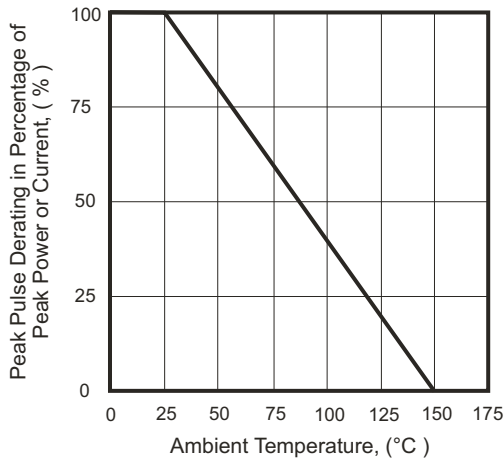

Fig.2 - Max. Non-Repetitive Surge Current

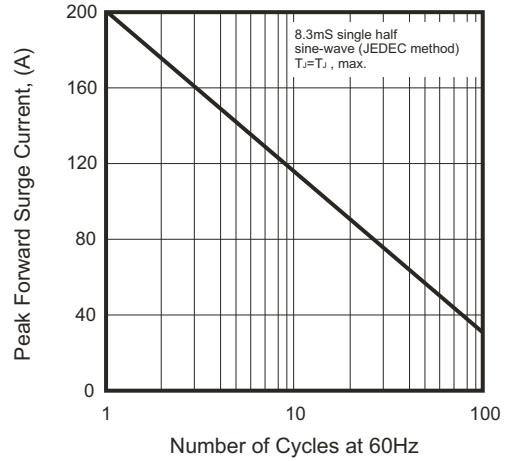

Fig.3 - Steady State Power Derating Curve

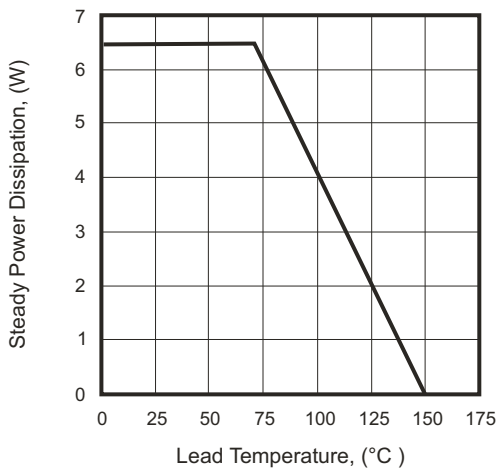

Fig.4 - Peak Pulse Power Rating Curve

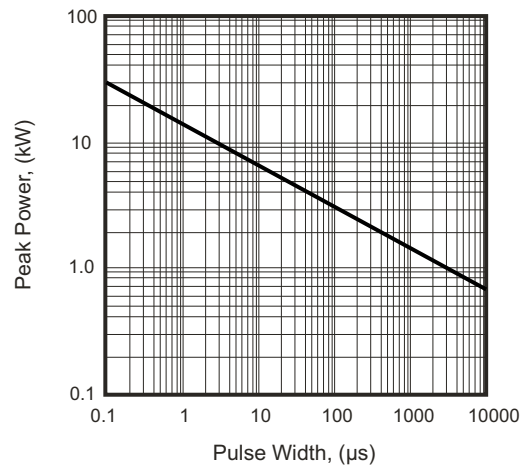

Fig.5 - Pulse Waveform

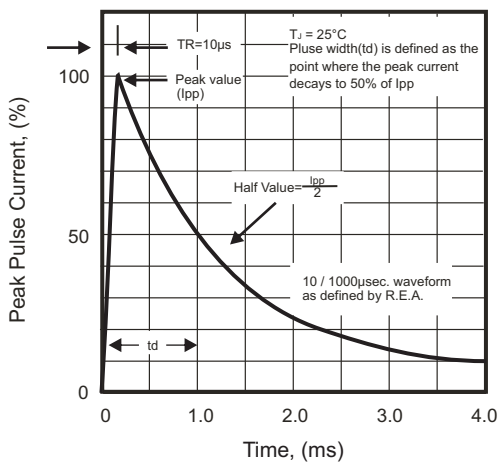
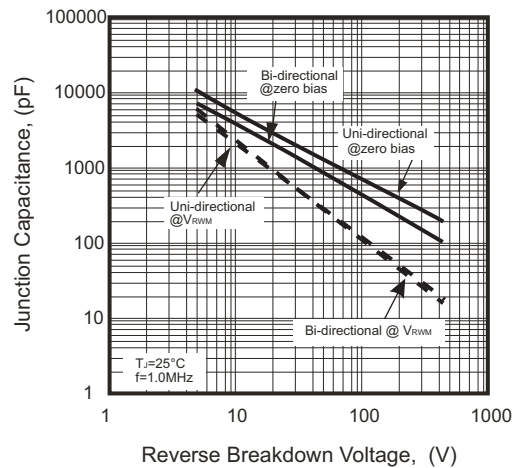

Fig.6 - Typical Junction Capacitance



SMD Transient Voltage Suppressor



Electrical Characteristics (ATV15C5V0-HF Thru. ATV15C441-HF)

Part No.	Breakdown voltage V _{BR} @ I _T			Maximum Reverse Leakage @V _{RWM} I _R (uA)	Working Peak Reverse Voltage V _{RWM} (V)	Maximum Reverse Surge Current I _{PP} (A)	Maximum Clamping Voltage @I _{PP} V _c (V)	Device Marking Code	
	Min. (V)	Max. (V)	I _T (mA)					UNI	BI
ATV15C5V0J(B)-HF	6.40	7.00	10	800	5.0	163.04	9.2	GDE	BDE
ATV15C6V0J(B)-HF	6.67	7.37	10	800	6.0	145.63	10.3	GDG	BDG
ATV15C6V5J(B)-HF	7.22	7.98	10	500	6.5	133.93	11.2	GDK	BDK
ATV15C7V0J(B)-HF	7.78	8.60	10	200	7.0	125.00	12.0	GDM	BDM
ATV15C7V5J(B)-HF	8.33	9.21	1	100	7.5	116.28	12.9	GDP	BDP
ATV15C8V0J(B)-HF	8.89	9.83	1	50	8.0	110.29	13.6	GDR	BDR
ATV15C8V5J(B)-HF	9.44	10.40	1	20	8.5	104.17	14.4	GDT	BDT
ATV15C9V0J(B)-HF	10.00	11.10	1	10	9.0	97.40	15.4	GDV	BDV
ATV15C100J(B)-HF	11.10	12.30	1	5.0	10.0	88.24	17.0	GDX	BDX
ATV15C110J(B)-HF	12.20	13.50	1	1.0	11.0	82.42	18.2	GDZ	BDZ
ATV15C120J(B)-HF	13.30	14.70	1	1.0	12.0	75.38	19.9	GEE	BEE
ATV15C130J(B)-HF	14.40	15.90	1	1.0	13.0	69.77	21.5	GEG	BEG
ATV15C140J(B)-HF	15.60	17.20	1	1.0	14.0	64.66	23.2	GEK	BEK
ATV15C150J(B)-HF	16.70	18.50	1	1.0	15.0	61.48	24.4	GEM	BEM
ATV15C160J(B)-HF	17.80	19.70	1	1.0	16.0	57.69	26.0	GEP	BEP
ATV15C170J(B)-HF	18.90	20.90	1	1.0	17.0	54.35	27.6	GER	BER
ATV15C180J(B)-HF	20.00	22.10	1	1.0	18.0	51.37	29.2	GET	BET
ATV15C190J(B)-HF	21.10	23.30	1	1.0	19.0	48.73	30.8	GEB	BEB
ATV15C200J(B)-HF	22.20	24.50	1	1.0	20.0	46.30	32.4	GEV	BEV
ATV15C220J(B)-HF	24.40	26.90	1	1.0	22.0	42.25	35.5	GEX	BEX
ATV15C240J(B)-HF	26.70	29.50	1	1.0	24.0	38.56	38.9	GEZ	BEZ
ATV15C260J(B)-HF	28.90	31.90	1	1.0	26.0	35.63	42.1	GFE	BFE
ATV15C280J(B)-HF	31.10	34.40	1	1.0	28.0	33.04	45.4	GFG	BFG
ATV15C300J(B)-HF	33.30	36.80	1	1.0	30.0	30.99	48.4	GFK	BFK
ATV15C330J(B)-HF	36.70	40.60	1	1.0	33.0	28.14	53.3	GFM	BFM
ATV15C360J(B)-HF	40.00	44.20	1	1.0	36.0	25.82	58.1	GFP	BFP
ATV15C400J(B)-HF	44.40	49.10	1	1.0	40.0	23.26	64.5	GFR	BFR
ATV15C430J(B)-HF	47.80	52.80	1	1.0	43.0	21.61	69.4	GFT	BFT
ATV15C450J(B)-HF	50.00	55.30	1	1.0	45.0	20.63	72.7	GFV	BFV
ATV15C480J(B)-HF	53.30	58.90	1	1.0	48.0	19.38	77.4	GFX	BFX
ATV15C510J(B)-HF	56.70	62.70	1	1.0	51.0	18.20	82.4	GFZ	BFZ
ATV15C540J(B)-HF	60.00	66.30	1	1.0	54.0	17.22	87.1	GGE	BGE
ATV15C580J(B)-HF	64.40	71.20	1	1.0	58.0	16.03	93.6	GGG	BGG
ATV15C600J(B)-HF	66.70	73.70	1	1.0	60.0	15.50	96.8	GGK	BGK
ATV15C640J(B)-HF	71.10	78.60	1	1.0	64.0	14.56	103.0	GGM	BGM
ATV15C700J(B)-HF	77.80	86.00	1	1.0	70.0	13.27	113.0	GGP	BGP
ATV15C750J(B)-HF	83.30	92.10	1	1.0	75.0	12.40	121.0	GGR	BGR
ATV15C780J(B)-HF	86.70	95.80	1	1.0	78.0	11.90	126.0	GGT	BGT
ATV15C800J(B)-HF	88.80	97.60	1	1.0	80.0	11.57	129.6	GGB	BGB
ATV15C850J(B)-HF	94.40	104.00	1	1.0	85.0	10.95	137.0	GGV	BGV
ATV15C900J(B)-HF	100.00	111.00	1	1.0	90.0	10.27	146.0	GGX	BGX
ATV15C101J(B)-HF	111.00	123.00	1	1.0	100.0	9.26	162.0	GGZ	BGZ
ATV15C111J(B)-HF	122.00	135.00	1	1.0	110.0	8.47	177.0	GHE	BHE
ATV15C121J(B)-HF	133.00	147.00	1	1.0	120.0	7.77	193.0	GHG	BHG

Company reserves the right to improve product design , functions and reliability without notice.

REV: B

Electrical Characteristics (ATV15C5V0-HF Thru. ATV15C441-HF)

Part No.	Breakdown voltage V _{BR} @ I _T			Maximum Reverse Leakage @V _{RWM} I _R (uA)	Working Peak Reverse Voltage V _{RWM} (V)	Maximum Reverse Surge Current I _{PP} (A)	Maximum Clamping Voltage @I _{PP} V _c (V)	Device Marking Code	
	Min. (V)	Max. (V)	I _T (mA)					UNI	BI
ATV15C131J(B)-HF	144.0	159.0	1	1.0	130.0	7.18	209.0	GHK	BHK
ATV15C141J(B)-HF	155.0	171.0	1	1.0	140.0	6.61	226.8	GHB	BHB
ATV15C151J(B)-HF	167.0	185.0	1	1.0	150.0	6.17	243.0	GHM	BHM
ATV15C161J(B)-HF	178.0	197.0	1	1.0	160.0	5.79	259.0	GHP	BHP
ATV15C171J(B)-HF	189.0	209.0	1	1.0	170.0	5.45	275.0	GHR	BHR
ATV15C181J(B)-HF	200.0	220.0	1	1.0	180.0	5.14	291.6	GHT	BHT
ATV15C191J(B)-HF	211.0	232.0	1	1.0	190.0	4.87	307.8	GHV	BHV
ATV15C201J(B)-HF	224.0	247.0	1	1.0	200.0	4.60	324.0	GHW	BHW
ATV15C221J(B)-HF	246.0	272.0	1	1.0	220.0	4.20	356.0	GHX	BHX
ATV15C251J(B)-HF	279.0	309.0	1	1.0	250.0	3.70	405.0	GHZ	BHZ
ATV15C301J(B)-HF	335.0	371.0	1	1.0	300.0	3.10	486.0	GJE	BJE
ATV15C351J(B)-HF	391.0	432.0	1	1.0	350.0	2.60	567.0	GJG	BJG
ATV15C401J(B)-HF	447.0	494.0	1	1.0	400.0	2.30	648.0	GJK	BJK
ATV15C441J(B)-HF	492.0	543.0	1	1.0	440.0	2.10	713.0	GJM	BJM

Note:

- 1) Suffix J denotes 5% tolerance devices.
- 2) Suffix B after part number to specify Bi-directional devices.
- 3) For Bi-Directional devices having V_R of 10 volts and under, the I_R limit is double.

Reel Taping Specification



DO-214AB (SMC)	SYMBOL	A	B	C	d	T	D	D ₁	D ₂
	(mm)	See Note 1			1.55 ± 0.05	0.40 (Max.)	330.00	50.00 (Min.)	13.00 ^{+0.50} _{-0.20}
	(inch)	See Note 1			0.061 ± 0.002	0.016 (Max.)	13.000	1.969 (Min.)	0.512 ^{+0.020} _{-0.008}
DO-214AB (SMC)	SYMBOL	E	F	P	P ₀	P ₁	W	W ₁	W ₂
	(mm)	1.75 ± 0.10	7.50 ± 0.05	8.00 ± 0.10	4.00 ± 0.10	2.00 ± 0.05	16.00 ± 0.10	16.40 ^{+2.00} _{-0.00}	22.40 (Max.)
	(inch)	0.069 ± 0.004	0.295 ± 0.002	0.315 ± 0.004	0.157 ± 0.004	0.079 ± 0.002	0.630 ± 0.004	0.646 ^{+0.079} _{-0.000}	0.882 (Max.)

Notes: 1. A, B, and C the clearance between the component and the cavity must be within 0.5 mm max. for 8 mm tape and 12 mm tape, 1.0 mm max. for 16mm tape and 24 mm tape.

Company reserves the right to improve product design , functions and reliability without notice.

REV: B

Marking Code

1. **C**: COMCHIP

2. ○: Package

○	PKG
A	SMA
B	SMB
C	SMC

3. XXX: Marking code (see Page. 3~4)

4. █: Cathod Band

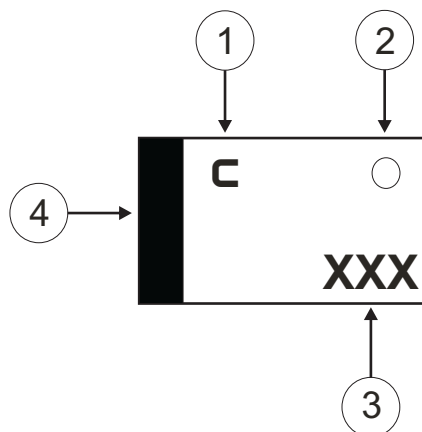

Suggested PAD Layout

SIZE	DO-214AB(SMC)	
	(mm)	(inch)
A	8.13	0.320
B	4.69 MAX	0.185 MAX
C	1.52 MIN	0.06 MIN
D	3.20 MIN	0.126 MIN

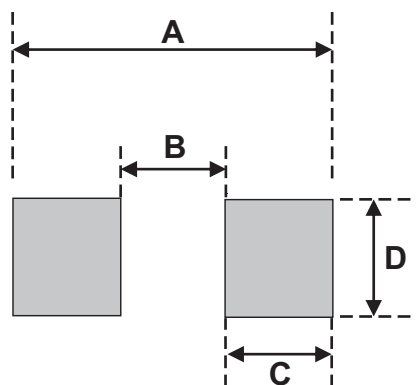

Standard Packaging

Case Type	REEL PACK	
	REEL (pcs)	Reel Size (inch)
DO-214AB (SMC)	3,000	13