

## CDBA320-HF Thru. CDBA3100-HF

Reverse Voltage: 20 to 100 Volts

Forward Current: 3.0 Amp

RoHS Device  
Halogen Free

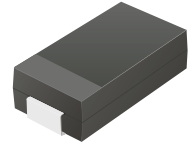

### Features

- Ideal for surface mount applications.
- Easy pick and place.
- Plastic package has Underwriters Lab. flammability classification 94V-0.
- Built-in strain relief.
- Low forward voltage drop.

### Mechanical data

- Case: JEDEC DO-214AC, molded plastic.
- Terminals: solderable per MIL-STD-750, method 2026.
- Polarity: Color band denotes cathode end.
- Approx. weight: 0.063 grams

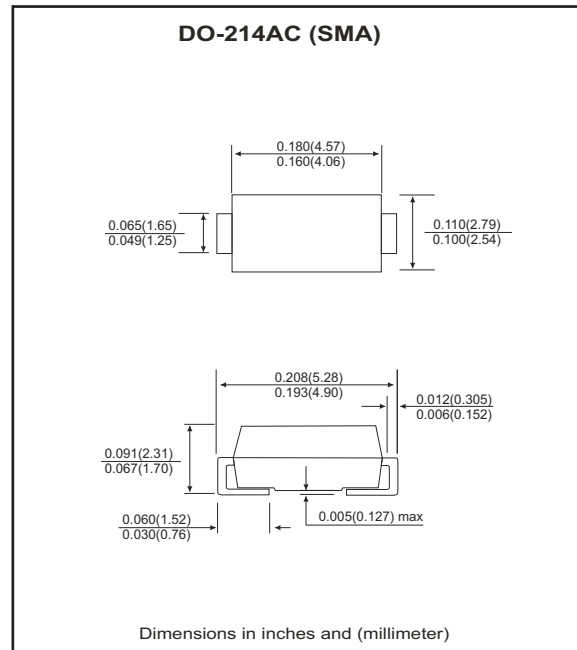

### Maximum Ratings and Electrical Characteristics

Parameter	Symbol	CDBA 320-HF	CDBA 340-HF	CDBA 360-HF	CDBA 380-HF	CDBA 3100-HF	Units
Max. repetitive peak reverse voltage	$V_{RRM}$	20	40	60	80	100	V
Max. DC blocking voltage	$V_{DC}$	20	40	60	80	100	V
Max. RMS voltage	$V_{RMS}$	14	28	42	56	70	V
Peak surge forward current, 8.3ms single half sine-wave superimposed on rate load (JEDEC method)	$I_{FSM}$	80					A
Max. average forward current	$I_o$	3.0					A
Max. instantaneous forward voltage at 3.0A	$V_F$	0.50		0.70		0.85	V
Max. DC reverse current at $T_A=25^{\circ}C$ rated DC blocking voltage $T_A=100^{\circ}C$	$I_R$	0.5					mA
		20			10		
Max. thermal resistance (Note 1)	$R_{\theta JA}$	50					$^{\circ}C/W$
	$R_{\theta JL}$	10					
Max. operating junction temperature	$T_J$	125					$^{\circ}C$
Storage temperature	$T_{STG}$	-65 to +150					$^{\circ}C$

Notes: 1. Thermal resistance from junction to ambient and junction to lead mounted on P.C.B. with 0.2x0.2 inch copper pad area.

## RATING AND CHARACTERISTIC CURVES (CDBA320-HF thru CDBA3100-HF)

Fig.1 Reverse Characteristics

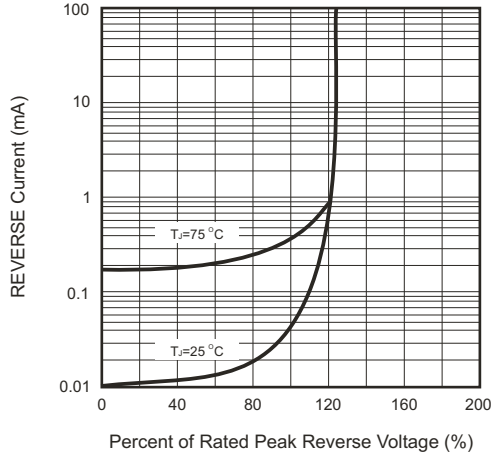

Fig.2 Forward Characteristics

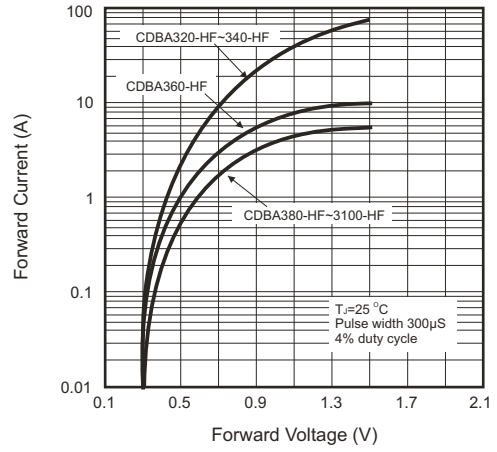

Fig.3 Junction Capacitance

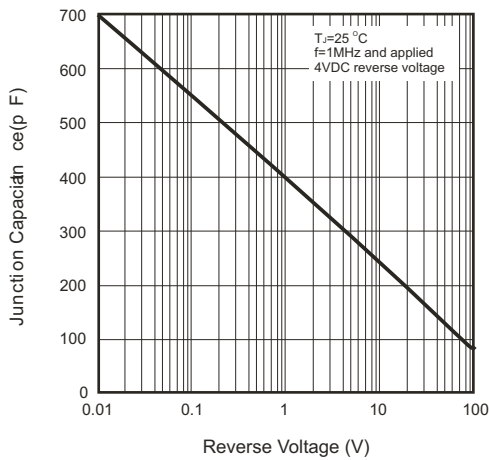

Fig.4 Current Derating Curve

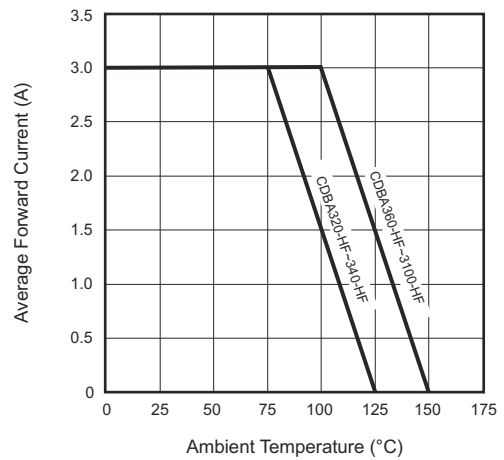
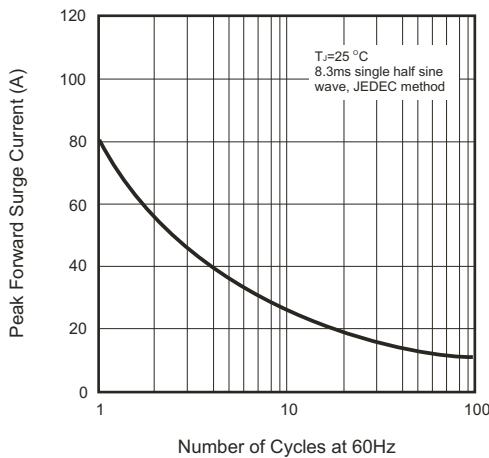
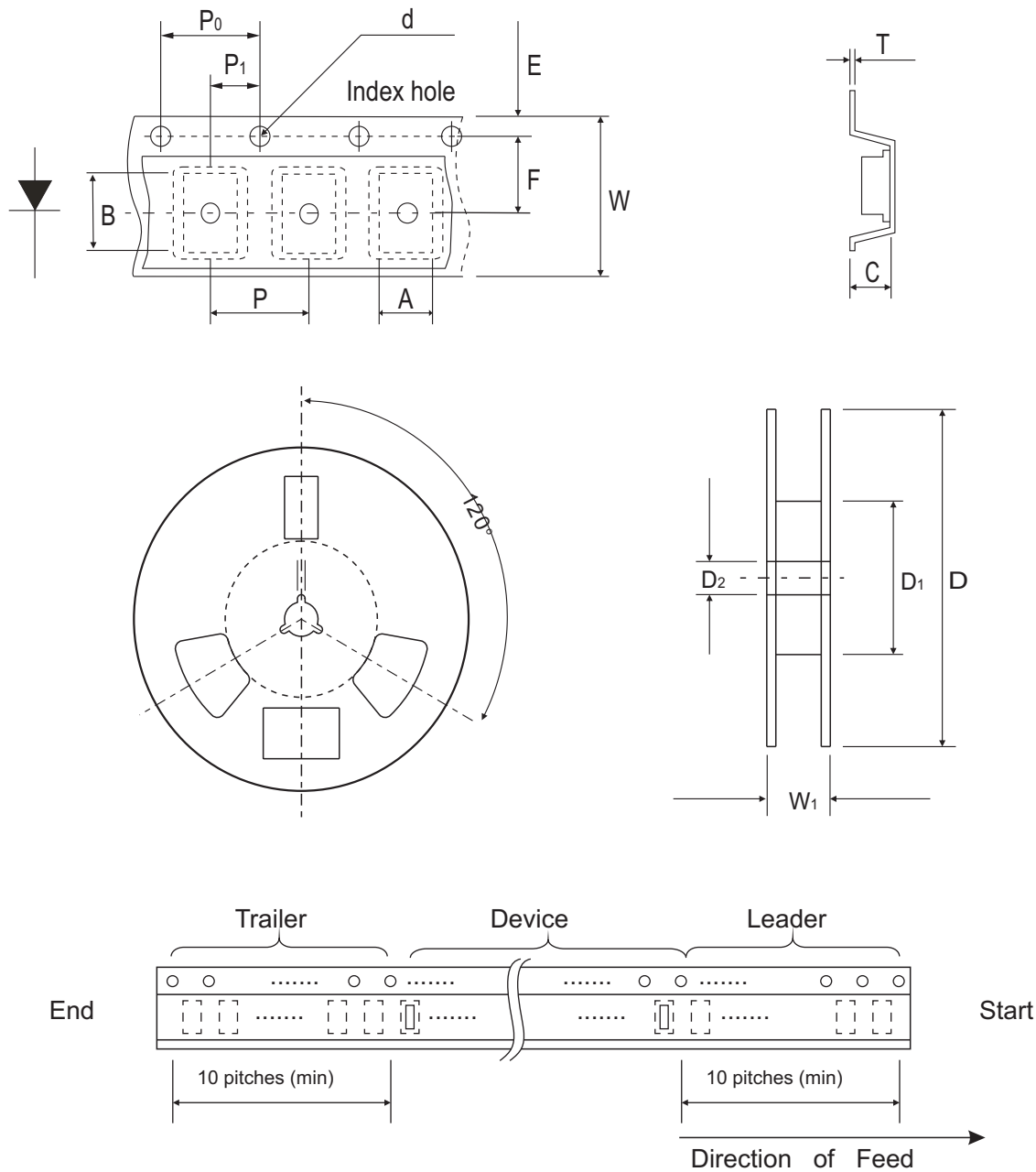

Fig.5 Non-repetitive Forward Surge Current



## Reel Taping Specification



DO-214AC (SMA)	SYMBOL	A	B	C	d	D	D1	D2
	(mm)	2.7 (max)	5.3 (max)	2.66 (max)	1.50 ± 0.10	330	50.0 MIN.	13.5 ± 1.00
	(inch)	0.106(max)	0.208 (max)	0.105 (max)	0.059 ± 0.004	13.00	1.969 MIN.	0.531 ± 0.039

DO-214AC (SMA)	SYMBOL	E	F	P	P0	P1	W	W1
	(mm)	1.75 ± 0.10	5.50 ± 0.05	4.00 ± 0.10	4.00 ± 0.10	2.00 ± 0.05	12.0 ± 0.20	18.4 MAX.
	(inch)	0.689 ± 0.004	0.216 ± 0.002	0.157 ± 0.004	0.157 ± 0.004	0.079 ± 0.002	0.472 ± 0.008	0.724 MAX

## Marking Code

Park Number	Marking Code
CDBA320-HF	320
CDBA340-HF	340
CDBA360-HF	360
CDBA380-HF	380
CDBA3100-HF	3100



xxxx = Product type marking code

## Suggested PAD Layout

SIZE	DO-214AC (SMA)	
	(mm)	(inch)
A	4.50	0.177
B	1.50	0.059
C	3.60	0.142
D	6.00	1.298
E	3.00	0.118

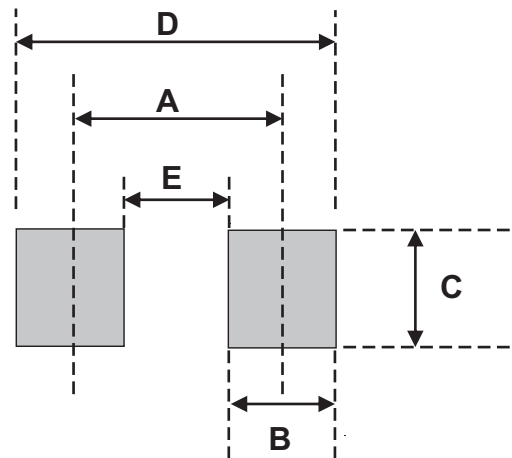

## Standard Packaging

Case Type	Qty per Reel	Reel Size
	(Pcs)	(inch)
DO-214AC (SMA)	5000	13