

## CDBAS340-HF

Reverse Voltage: 40 Volts

Forward Current: 3.0 Amp

RoHS Device

Halogen Free

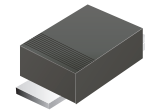

### Features

- High surge and current capability
- For use in low voltage, high frequency invertors free wheeling and polarity protection
- Built-in strain relief
- Silicon epitaxial planar chips
- Metal silicon junction with guard ring

### Mechanical data

- Epoxy: UL94-V0 rate flame retardant
- Case: Molded plastic, SMA-S
- Terminals: Solder plated solderable per MIL-STD-750 method 2026
- Polarity: Color band denotes cathode end
- Mounting position: Any
- Weight: 0.045 grams(approx.)

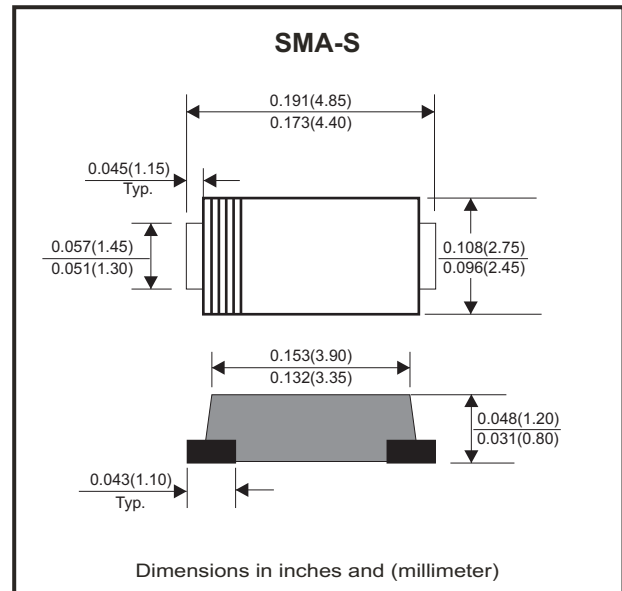

### Circuit diagram



### Maximum Ratings and Electrical Characteristics (at T<sub>A</sub>=25°C unless otherwise noted)

Parameter	Symbol	Value	Unit
Maximum recurrent peak reverse voltage	V <sub>RRM</sub>	40	V
Maximum DC blocking voltage	V <sub>DC</sub>	40	V
Maximum RMS voltage	V <sub>RMS</sub>	28	V
Maximum forward voltage at 3.0A (note1)	V <sub>F</sub>	0.50	V
Maximum average forward current 0.2 x0.2" (5.0x5.0mm) copper pad area, see Figure 1	I <sub>F(AV)</sub>	3.0	A
Peak forward surge current 8.3ms single half sine-wave superimposed on rate load (JEDEC method)	I <sub>FSM</sub>	80	A
Maximum DC reverse current at rated DC blocking voltage	I <sub>R</sub>	T <sub>A</sub> =25°C	0.1
		T <sub>A</sub> =100°C	20
Typical junction capacitance (note2)	C <sub>J</sub>	250	pF
Typical thermal resistance (note3)	Junction to lead	R <sub>θJL</sub>	17
	Junction to Ambient	R <sub>θJA</sub>	55
Operating junction temperature range	T <sub>J</sub>	-55 to +125	°C
Storage temperature range	T <sub>STG</sub>	-55 to +150	°C

Notes: 1. Pulse test: 300μS pulse width,1% duty cycle  
 2. Measured at 1.0MHz and applied reverse voltage of 4.0 volts  
 3. Thermal resistance from junction to ambient and from junction to lead P.C.B. mounted on 0.2x0.2"(5.0x5.0mm) copper pad areas.

## RATING AND CHARACTERISTIC CURVES ( CDBAS340-HF )

Fig. 1 - Forward Current Derating Curve

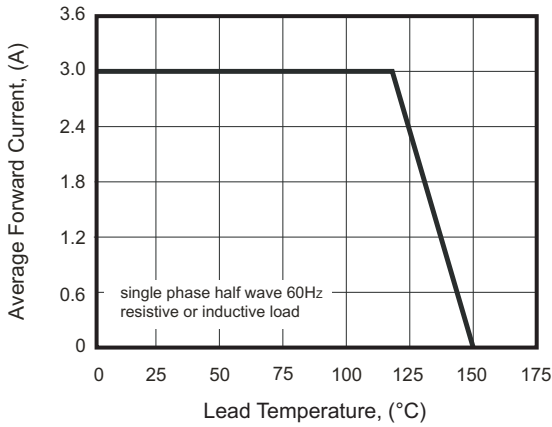

Fig. 2 - Maximum Non-Repetitive Peak Forward Surge Current

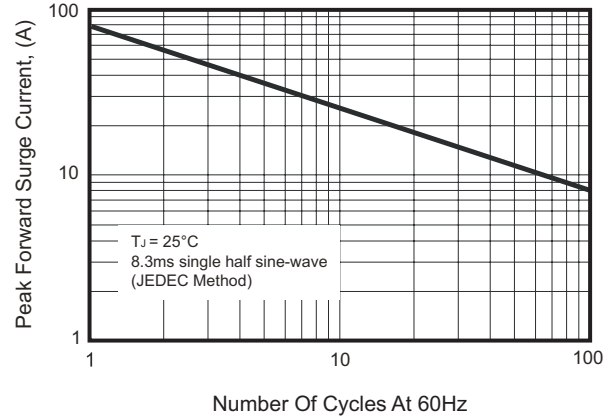

Fig. 3 - Typical Instantaneous Forward Characteristics

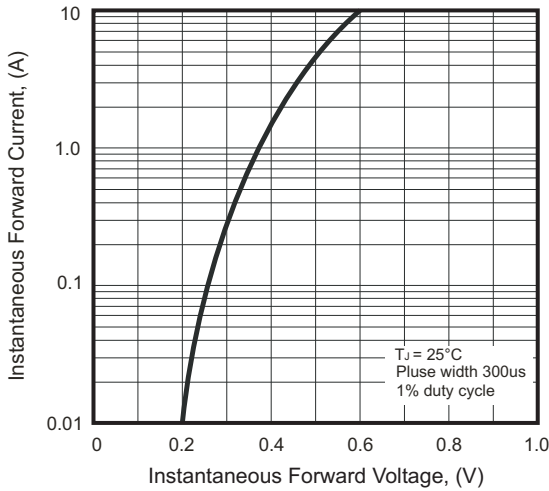

Fig. 4 - Typical Reverse Characteristics

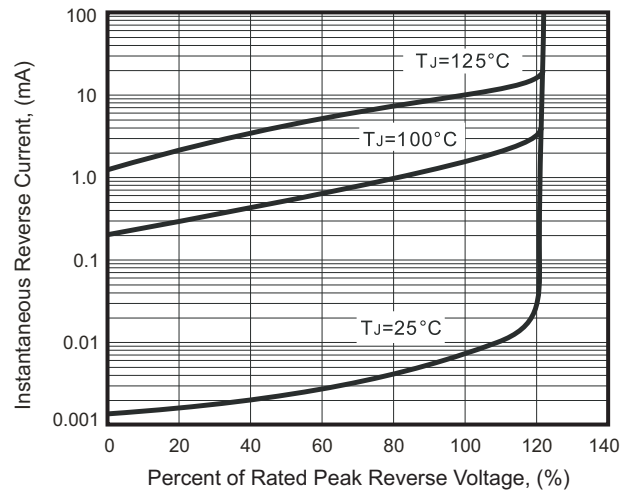
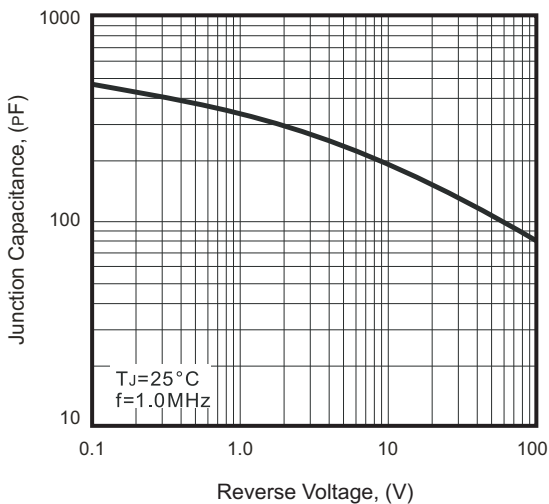
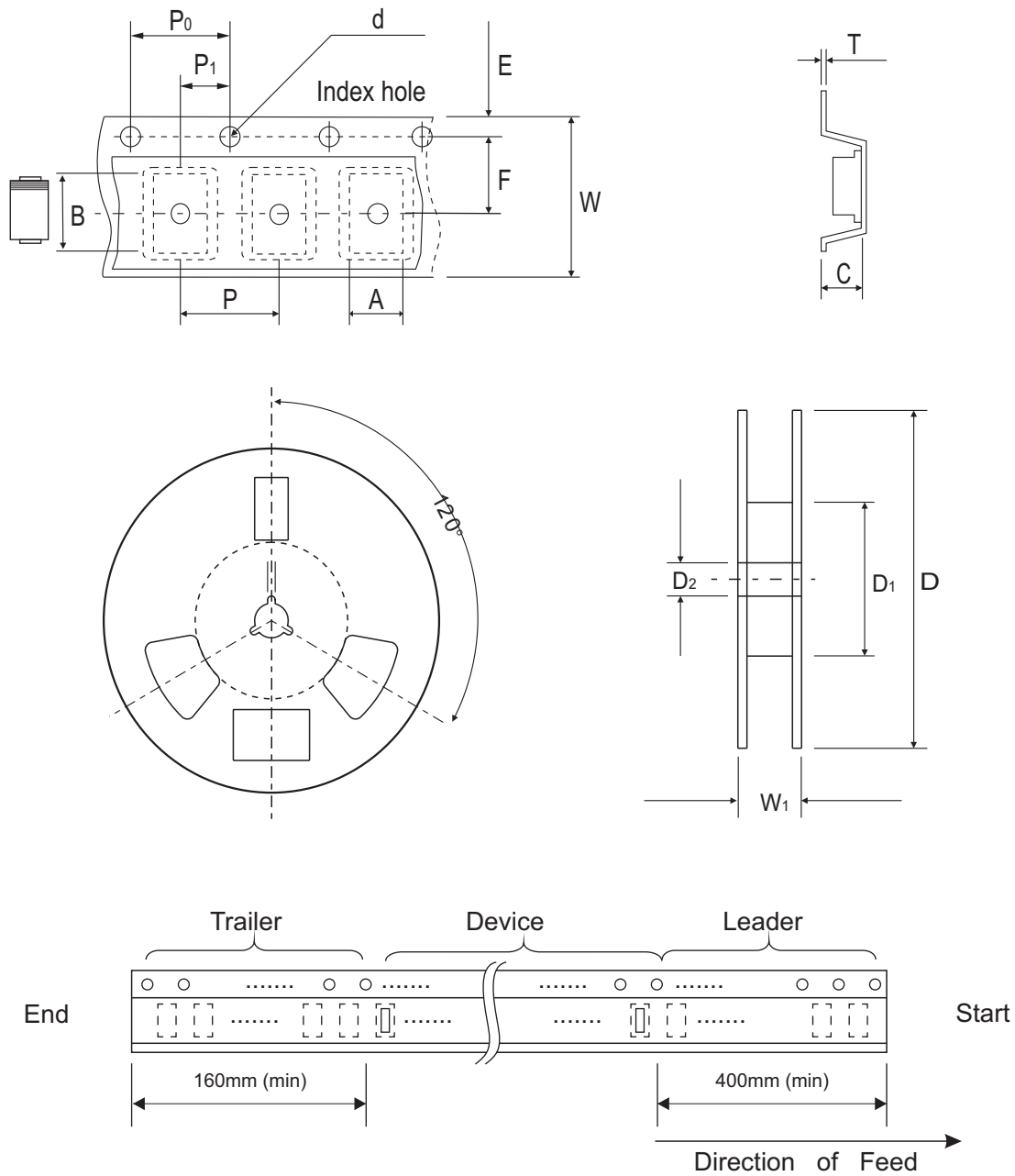

Fig. 5 - Typical Junction Capacitance



## Reel Taping Specification



SMA-S	SYMBOL	A	B	C	d	D	D1	D2
	(mm)	2.85 ± 0.10	5.10 ± 0.10	1.25 ± 0.05	1.55 ± 0.05	178.00 ± 2.00	75.00 ± 2.00	13.00 ± 0.50
	(inch)	0.112 ± 0.004	0.201 ± 0.004	0.049 ± 0.002	0.061 ± 0.002	7.008 ± 0.079	2.953 ± 0.079	0.512 ± 0.020

SMA-S	SYMBOL	E	F	P	P0	P1	T	W	W1
	(mm)	1.75 ± 0.10	5.50 ± 0.05	4.00 ± 0.10	4.00 ± 0.10	2.00 ± 0.05	0.25 ± 0.05	12.00 ± 0.10	16.80 ± 4.00
	(inch)	0.069 ± 0.004	0.217 ± 0.002	0.157 ± 0.004	0.157 ± 0.004	0.079 ± 0.002	0.010 ± 0.002	0.472 ± 0.004	0.661 ± 0.157

## Marking Code

Part Number	Marking Code
CDBAS340-HF	34S



|||| = Cathod band

xxx = Product type marking code

## Suggested PAD Layout

SIZE	DO-214AC/SMA-S	
	(mm)	(inch)
A	1.90	0.075
B	1.60	0.063
C	2.70	0.106
D	5.90	0.232

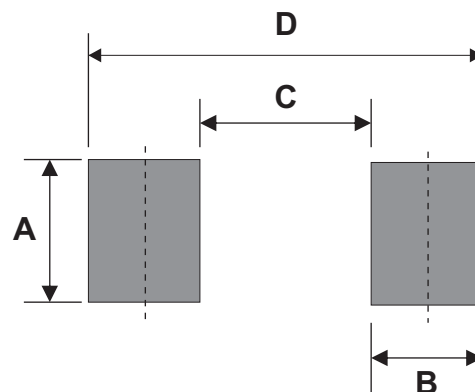

## Standard Packaging

Case Type	REEL PACK	
	REEL ( pcs )	Reel Size (inch)
DO-214AC (SMA-S)	3,000	7