

## CDBHM220L-G Thru. CDBHM2100L-G

Reverse Voltage: 20 to 100 Volts

Forward Current: 2.0 Amp

RoHS Device

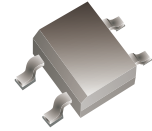

### Features

- For surface mounted applications.
- Metal-Semiconductor junction with guarding.
- Epitaxial construction.
- Very low forward voltage drop.
- High current capability
- Plastic material has UL flammability classification 94V-0
- For use in low voltage, high frequency inverters, free wheeling, and polarity protection applications.

### Mechanical data

- Case: molded plastic.
- Polarity: Indicated by cathode band.
- Weight: 0.125 grams (approx.).

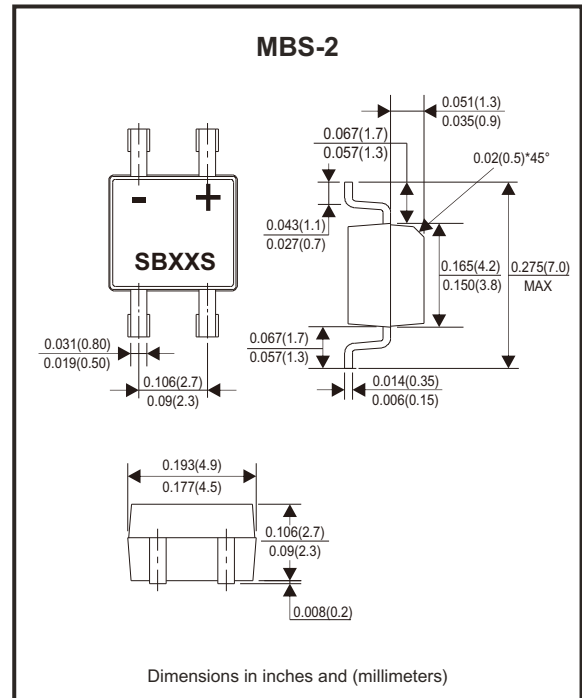

### Maximum Rating and Electrical Characteristics

Rating at  $T_A=25^{\circ}\text{C}$ , unless otherwise noted.  
Single phase, half wave, 60Hz, resistive or inductive load.  
For capacitive load, derate current by 20%.

Parameter	Symbol	CDBHM 220L-G	CDBHM 230L-G	CDBHM 240L-G	CDBHM 250L-G	CDBHM 260L-G	CDBHM 280L-G	CDBHM 290L-G	CDBHM 2100L-G	Unit
	Marking	SB22S	SB23S	SB24S	SB25S	SB26S	SB28S	SB29S	SB210S	
Maximum Recurrent Peak Reverse Voltage	$V_{RRM}$	20	30	40	50	60	80	90	100	V
Maximum RMS Voltage	$V_{RMS}$	14	21	28	35	42	56	63	70	V
Maximum DC Blocking Voltage	$V_{DC}$	20	30	40	50	60	80	90	100	V
Maximum Average Forward Rectified Current @ $T_L=100^{\circ}\text{C}$	$I_{(AV)}$	2.0								A
Peak Forward Surge Current, 8.3mS single half sine-wave, superimposed on rated load (JEDEC Method)	$I_{FSM}$	50								A
Maximum Forward Voltage at 2.0A DC	$V_F$	0.55		0.70		0.85			V	
Maximum DC Reverse Current at Rated DC Blocking Voltage @ $T_J=25^{\circ}\text{C}$ @ $T_J=100^{\circ}\text{C}$	$I_R$	1.0 20								mA
Typical Junction Capacitance (Note 1)	$C_J$	125								pF
Typical Thermal Resistance (Note 2)	$R_{\theta JA}$	20								$^{\circ}\text{C}/\text{W}$
Operating Temperature Range	$T_J$	-55 to +125								$^{\circ}\text{C}$
Storage Temperature Range	$T_{STG}$	-55 to +150								$^{\circ}\text{C}$

Notes: 1. Measured at 1.0MHz and applied reverse voltage of 4.0V DC.  
2. Thermal resistance junction to lead.

# Low Vf SMD Schottky Bridge Rectifiers

## Rating and Characteristic Curves (CDBHM220L-G Thru. CDBHM2100L-G)

Fig.1 - Forward Current Derating Curve

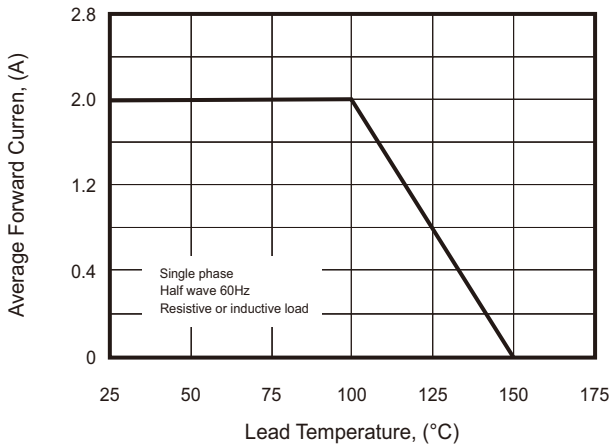

Fig. 2 - Maximum Non-Repetitive Surge Current

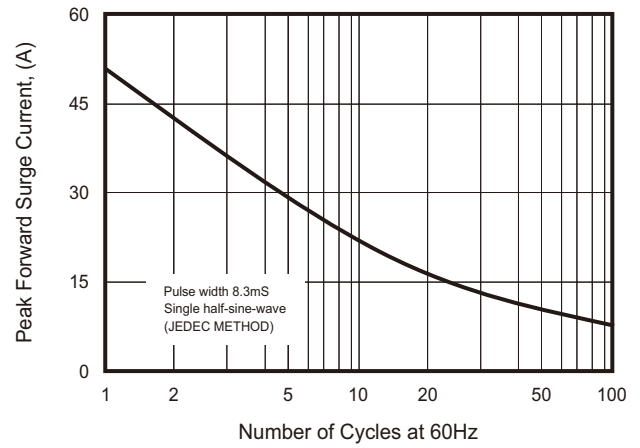

Fig.3 - Typical Forward Characteristics

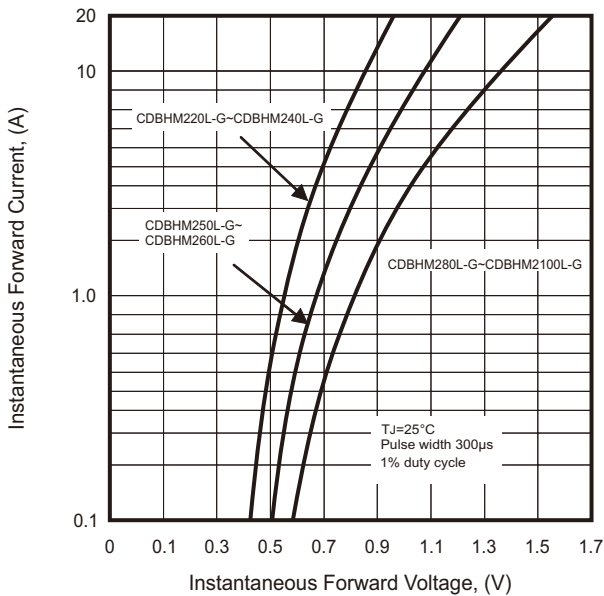

Fig.4 - Typical Junction Capacitance

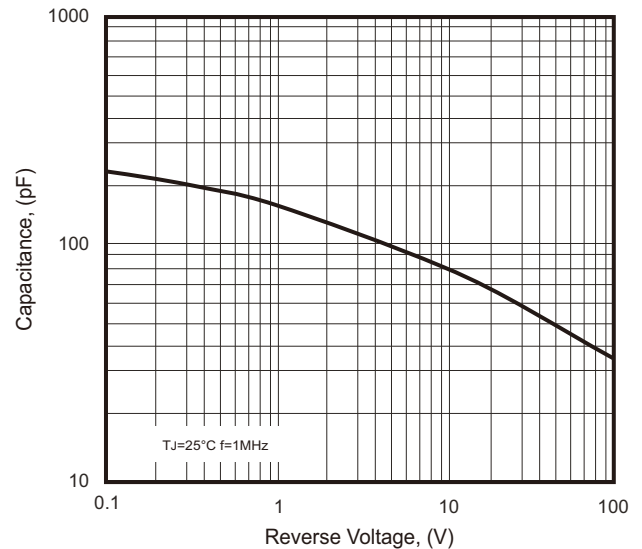
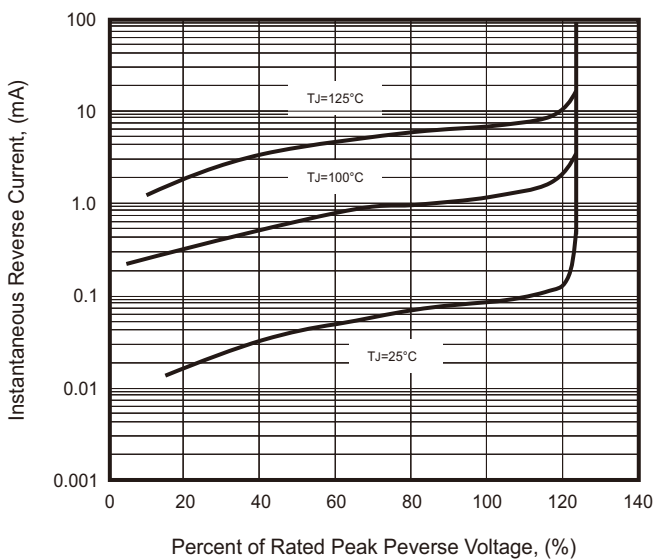
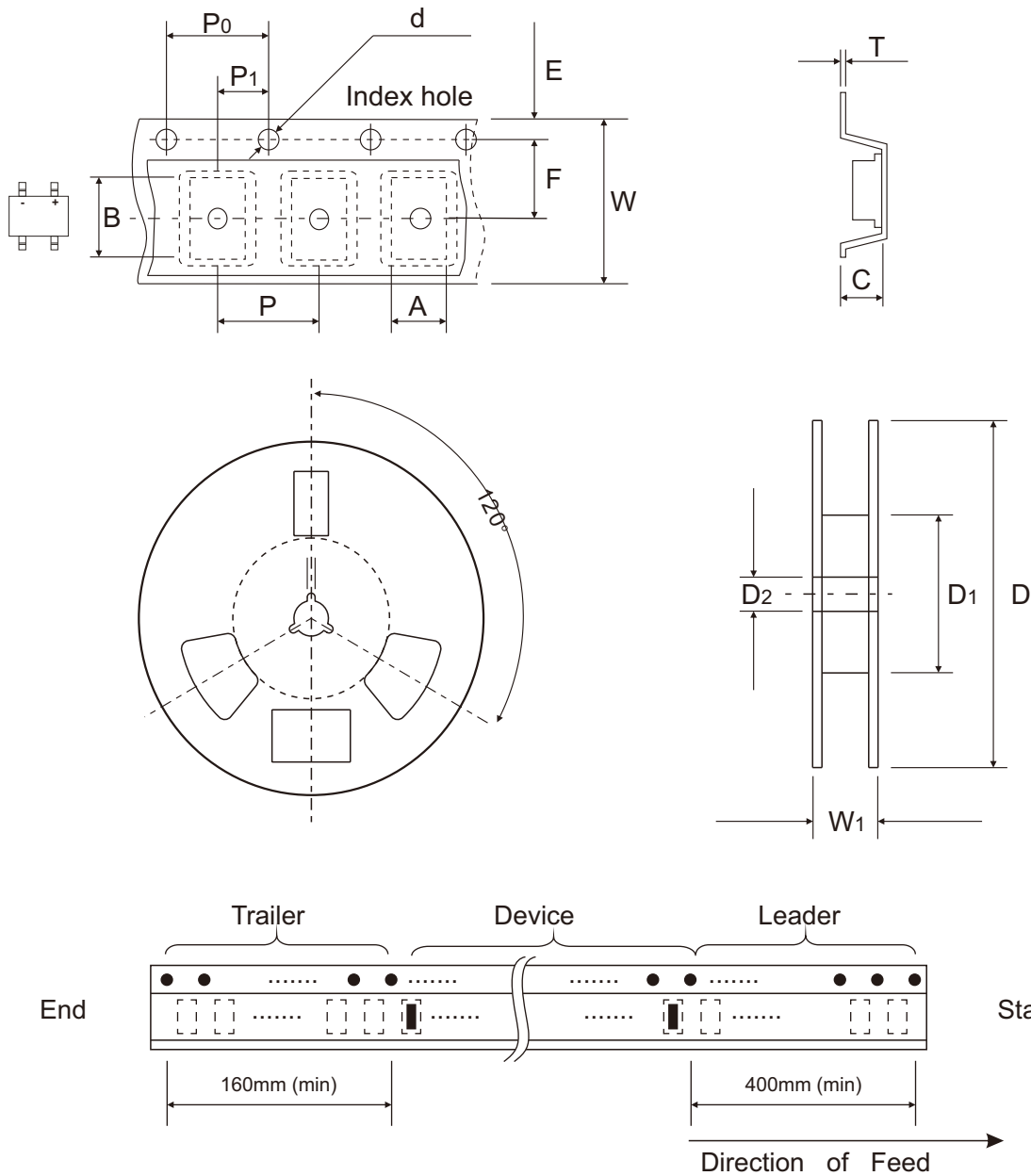

Fig.5 - Typical Reverse Characteristics



## Reel Taping Specification



MBS-2	SYMBOL	A	B	C	d	D	D1	D2
	(mm)	4.90 ± 0.01	7.24 ± 0.10	3.33 ± 0.10	1.55 ± 0.10	330.0	50.0 MIN.	13.0 ± 0.20
	(inch)	0.93 ± 0.004	0.285 ± 0.004	0.131 ± 0.004	0.0610 ± 0.004	13.00	1.969 MIN.	0.512 ± 0.008

MBS-2	SYMBOL	E	F	P	P0	P1	W	W1
	(mm)	1.75 ± 0.10	5.50 ± 0.05	8.00 ± 0.10	4.00 ± 0.10	2.00 ± 0.05	12.00 ± 0.30	12.0~14.40
	(inch)	0.069 ± 0.004	0.217 ± 0.002	0.315 ± 0.004	0.157 ± 0.004	0.079 ± 0.002	0.472 ± 0.012	0.472~0.657

Company reserves the right to improve product design , functions and reliability without notice.

REV:C

## Suggested PAD Layout

SIZE	MBS-2	
	(mm)	(inch)
A	2.55 REF	0.100 REF
B	0.82 MIN	0.032 MIN
C	0.92 MIN	0.036 MIN
D	7.00 MAX	0.276 MAX

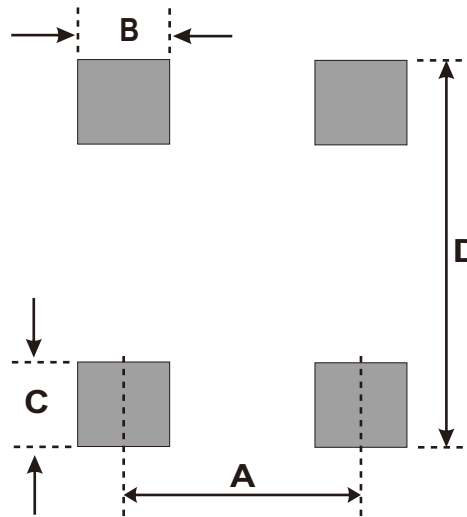

## Standard Packaging

Case Type	REEL PACK	
	REEL ( pcs )	Reel Size (inch)
MBS-2	3,000	13