

CDSV6-99SD-G

Reverse Voltage: 75 Volts

Forward Current: 150 mA

RoHS Device

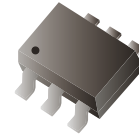

Features

- Fast switching speed.
- Ultra small surface mount package.
- For general purpose switching applications.
- High Conductance.

Mechanical data

- Case: SOT-363, molded plastic.
- Terminals: Solderable per MIL-STD-750, method 2026.
- Weight: 0.006 grams approx.

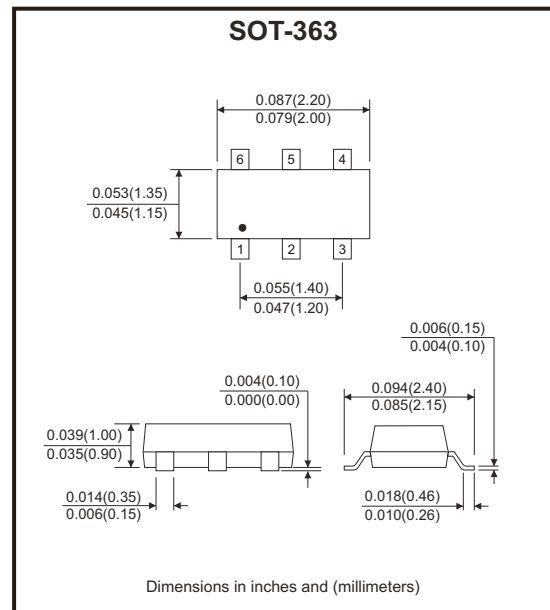

Circuit Diagram

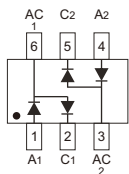

Maximum Ratings (at Ta=25°C unless otherwise noted)

Parameter	Symbol	Limits	Unit
Peak repetitive peak reverse voltage	V_{RRM}	75	V
Working peak reverse voltage	V_{RWM}		
DC blocking voltage	V_R		
Forward continuous current	I_{FM}	300	mA
Average rectified output current	I_o	150	mA
Non-repetitive peak forward surge current @ t=8.3ms	I_{FSM}	2	A
Power dissipation	P_D	200	mW
Thermal resistance junction to ambient	$R_{\theta JA}$	625	°C/W
Operation junction temperature	T_J	150	°C
Storage temperature range	T_{STG}	-55 ~ +150	°C

Electrical Characteristics (at Ta=25°C unless otherwise noted)

Parameter	Symbol	Conditions	Min	Typ	Max	Unit
Reverse breakdown voltage	$V_{(BR)}$	$I_R=2.5\mu A$	75			V
Reverse current	I_R	$V_R=75V$			2.5	μA
		$V_R=20V$			25	nA
Forward voltage	V_F	$I_F=1mA$			0.715	V
		$I_F=10mA$			0.855	
		$I_F=50mA$			1	
		$I_F=150mA$			1.25	
Total capacitance	C_{tot}	$V_R=0V, f=1MHz$			2	pF
Reverse recovery time	t_{rr}	$I_F=I_R=10mA, I_{rr}=0.1 \times I_R, R_L=100\Omega$			4	ns

Rating and Characteristic Curves (CDSV6-99SD-G)

Fig.1 - Forward Characteristics

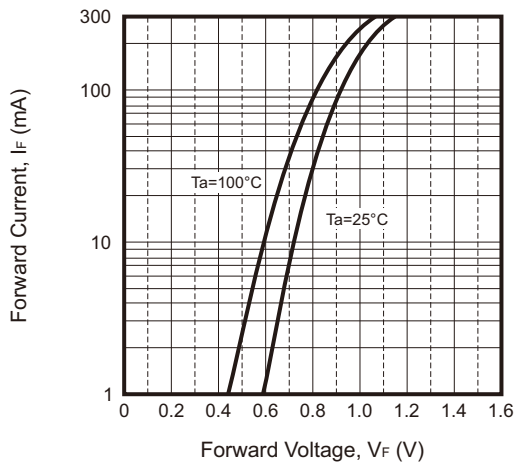

Fig.2 - Reverse Characteristics

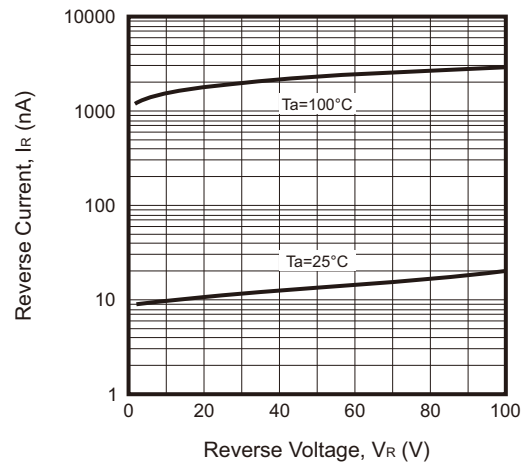

Fig.3 - Capacitance Characteristics

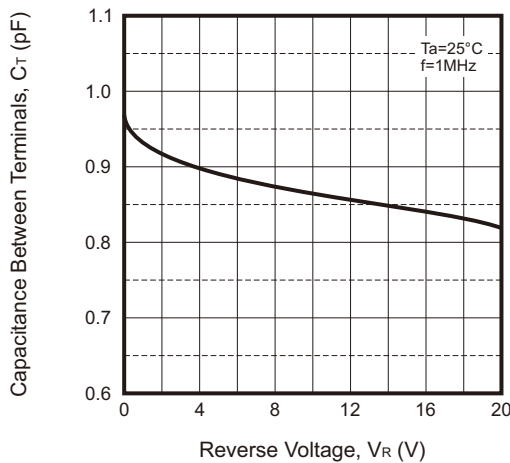
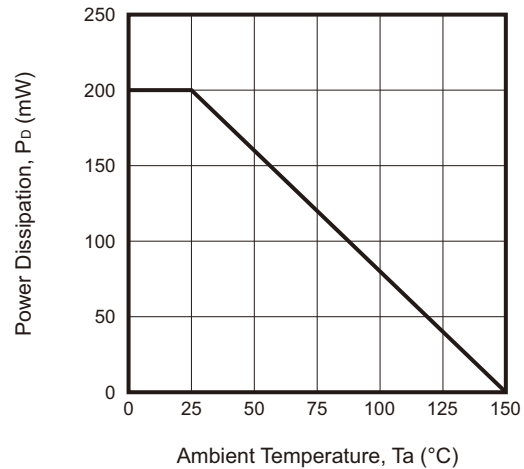
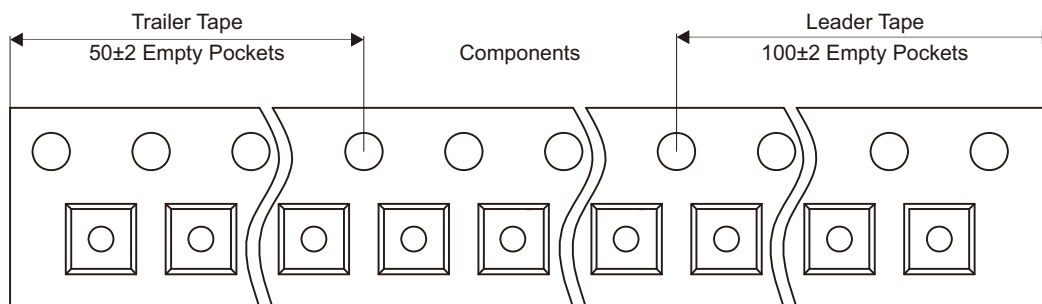
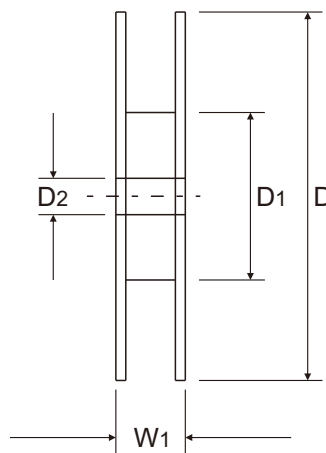
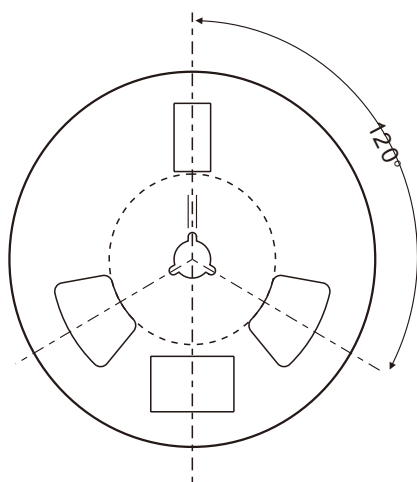
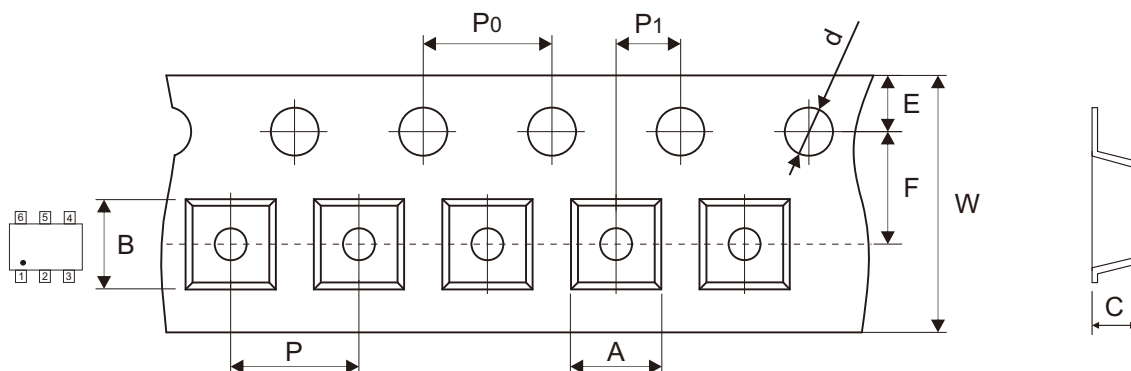

Fig.4 - Power Derating Curve



Company reserves the right to improve product design, functions and reliability without notice.

Reel Taping Specification



SOT-363	SYMBOL	A	B	C	d	D	D1	D2
	(mm)	2.25 ± 0.10	2.55 ± 0.10	1.20 ± 0.10	1.50 + 0.10 - 0.00	178.00 ± 1.00	54.40 ± 0.40	13.00 ± 0.20
	(inch)	0.089 ± 0.004	0.100 ± 0.004	0.047 ± 0.004	0.059 + 0.004 - 0.000	7.008 ± 0.039	2.142 ± 0.016	0.512 ± 0.008

SOT-363	SYMBOL	E	F	P	P0	P1	W	W1
	(mm)	1.75 ± 0.10	3.50 ± 0.05	4.00 ± 0.10	4.00 ± 0.10	2.00 ± 0.05	8.00 + 0.30 - 0.10	12.30 ± 1.00
	(inch)	0.069 ± 0.004	0.138 ± 0.002	0.157 ± 0.004	0.157 ± 0.004	0.079 ± 0.002	0.315 + 0.012 - 0.004	0.484 ± 0.039

Company reserves the right to improve product design, functions and reliability without notice.

REV:B

Marking Code

Part Number	Marking Code
CDSV6-99SD-G	KJG

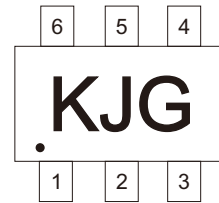

Solid dot “ • ” = Pin 1 indicate.

Suggested PAD Layout

SIZE	SOT-363	
	(mm)	(inch)
A	0.40	0.016
B	0.80	0.031
C	0.65	0.026
D	1.94	0.076

Note: 1.General tolerance: $\pm 0.05\text{mm}$.
2.The pad layout is for reference purposes only.

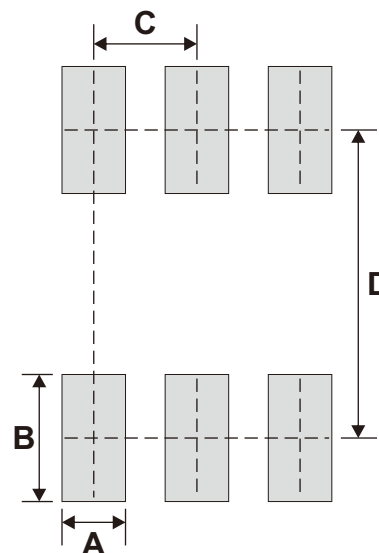

Standard Packaging

Case Type	REEL PACK	
	REEL (pcs)	Reel Size (inch)
SOT-363	3,000	7