

BAV99RW-HF

**RoHS Device
Halogen Free**

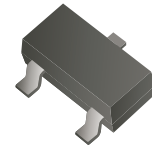

Features

- Fast switching speed.
- High conductance.

Mechanical data

- Case: SOT-323, molded plastic.
- Molding compound: UL flammability classification rating 94V-0.
- Terminals: Matte tin-plated leads, solderability per MIL-STD-202, method 208.

Circuit Diagram

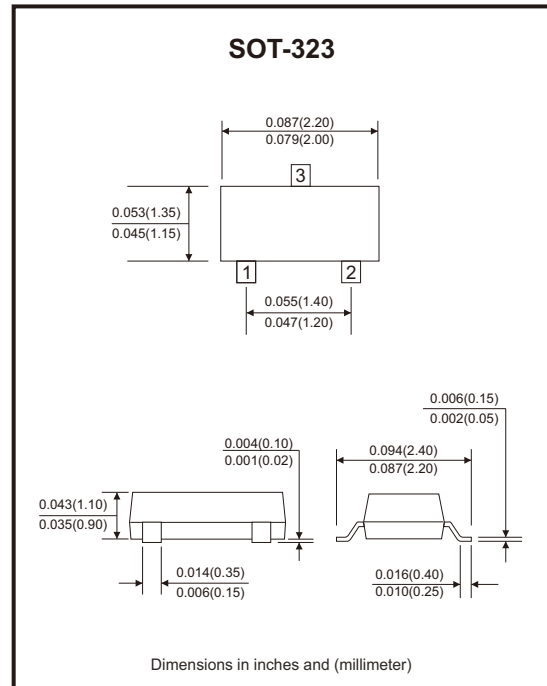
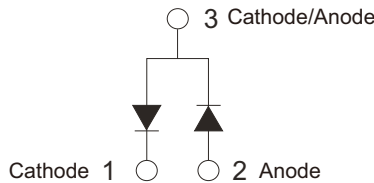

Maximum Ratings (at TA=25°C unless otherwise noted)

Parameter	Symbol	Value	Unit
Peak repetitive peak reverse voltage	V _R RM	70	V
DC blocking voltage	V _R	70	V
Forward continuous current	I _F	215	mA
Average rectified output current @ averaged over any 20ms period (Note 1)	I _{F(AV)}	715	mA
Non-repetitive peak forward surge current @ t = 8.3ms	I _{FSM}	2	A
Peak forward surge current	I _{FM(surge)}	500	mA
Repetitive peak forward surge current	I _{FRM}	450	mA
Power dissipation	P _D	200	mW
Thermal resistance junction to air (Note 2)	R _{θJA}	466	°C/W
Thermal resistance junction to case (Note 2)	R _{θJC}	250	°C/W
Thermal resistance junction to lead (Note 2)	R _{θJL}	271	°C/W
Operating junction temperature range	T _J	-65 to +150	°C
Storage temperature range	T _{STG}	-65 to +150	°C

Notes: 1. FR-5 = 1.0 x 0.75 x 0.062 in.

2. The data tested by surface mounted on a 15mm x 15mm x 1mm FR4-epoxy P.C.B.

Electrical Characteristics (at TA=25°C unless otherwise noted)

Parameter	Conditions	Symbol	Min.	Typ.	Max.	Unit
Reverse breakdown voltage	$I_R = 100\mu A$	V_{BR}	70			V
Forward voltage	$I_F = 1mA$	V_F			0.715	V
	$I_F = 10mA$	V_F			0.855	
	$I_F = 50mA$	V_F			1.000	
	$I_F = 150mA$	V_F			1.250	
Maximum peak reverse current	$V_R = 70V$	I_R			2.5	μA
Total capacitance	$V_R = 0V, f = 1MHz$	C_J			1.5	pF
Reverse recovery time	$I_F = I_R = 10mA, I_{rr} = 0.1 \times I_R, R_L = 100\Omega$	t_{rr}			6	nS
Forward recovery time	$I_F = 10mA, t_r = 20ns$	V_{FR}			1.75	V

Rating and Characteristic Curves (BAV99RW-HF)

Fig.1 - Typical Reverse Characteristics

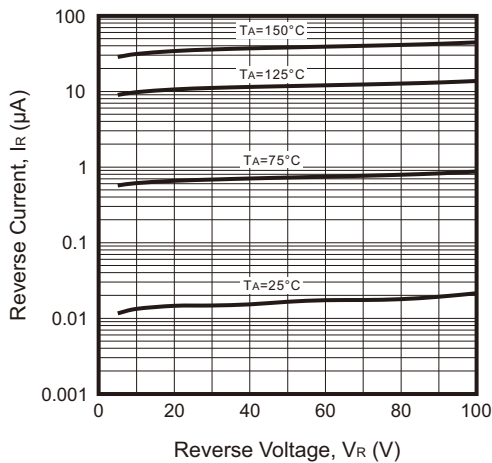

Fig.2 - Typical Forward Characteristics

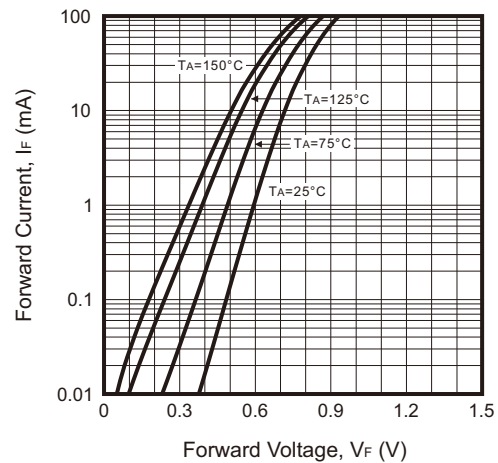

Fig.3 - Capacitance vs. Reverse Voltage

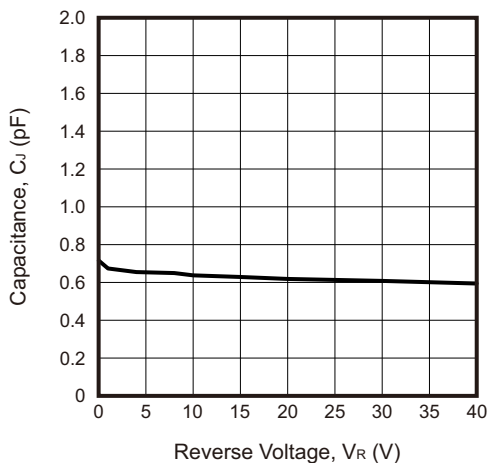
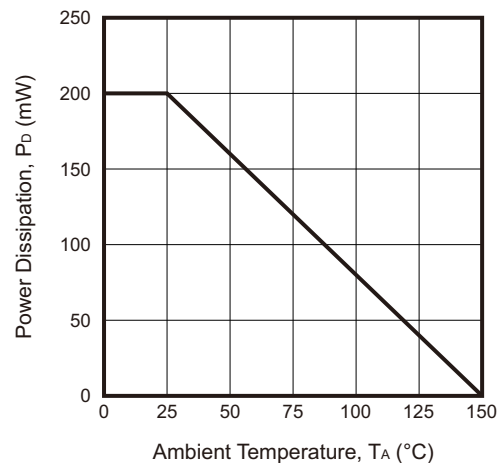
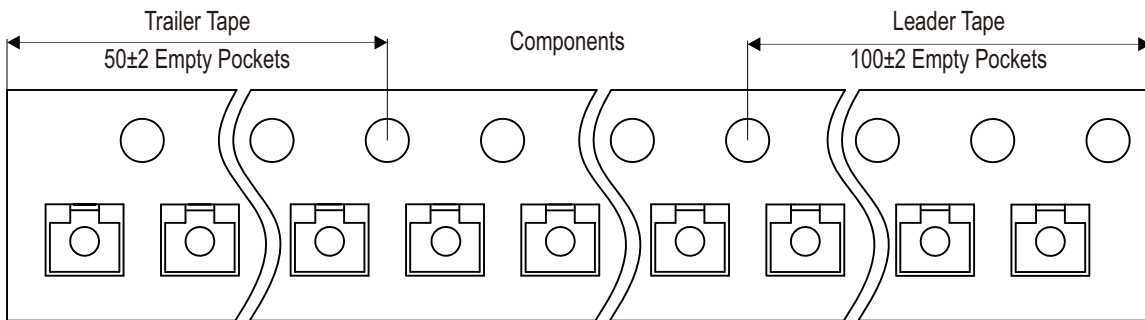
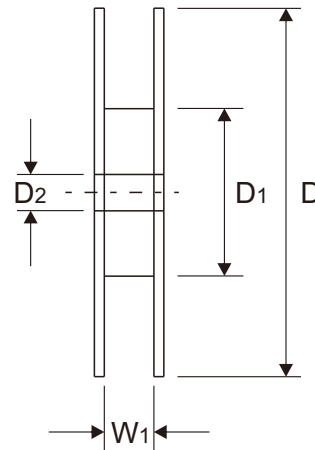
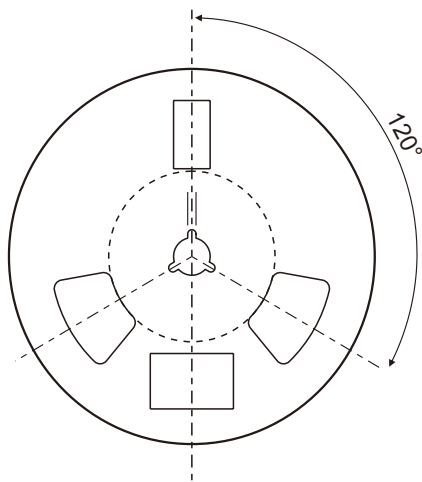
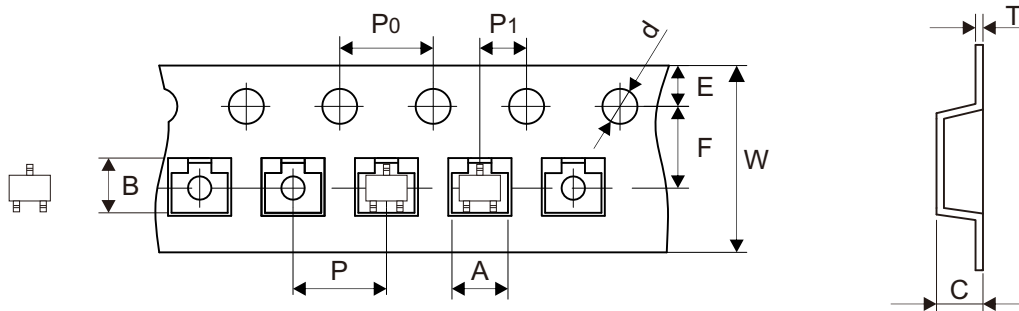

Fig.4 - Power Derating Curve



Reel Taping Specification



SOT-323	SYMBOL	A	B	C	d	D	D1	D2
	(mm)	2.25 ± 0.10	2.55 ± 0.10	1.19 ± 0.10	1.50 ± 0.10	178.00 ± 1.00	54.00 ± 0.50	13.00 ± 0.50
	(inch)	0.089 ± 0.004	0.100 ± 0.004	0.047 ± 0.004	0.059 ± 0.004	7.008 ± 0.039	2.126 ± 0.020	0.512 ± 0.020

SOT-323	SYMBOL	E	F	P	P0	P1	T	W	W1
	(mm)	1.75 ± 0.10	3.50 ± 0.10	4.00 ± 0.10	4.00 ± 0.10	2.00 ± 0.05	0.22 ± 0.02	8.00 + 0.30 - 0.10	9.50 ± 1.00
	(inch)	0.069 ± 0.004	0.138 ± 0.004	0.157 ± 0.004	0.157 ± 0.004	0.079 ± 0.002	0.009 ± 0.001	0.315 + 0.012 - 0.004	0.374 ± 0.039

Marking Code

Part Number	Marking Code
BAV99RW-HF	F7

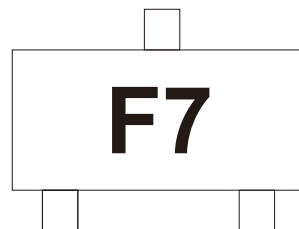

Suggested P.C.B. PAD Layout

SIZE	SOT-323	
	(mm)	(inch)
A	0.90	0.035
B	0.70	0.028
C	0.65	0.026
D	1.90	0.075

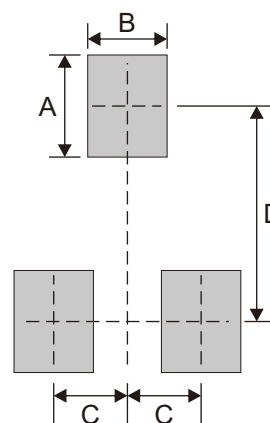

Standard Packaging

Case Type	REEL PACK	
	REEL (pcs)	Reel Size (inch)
SOT-323	3,000	7