

1SS389-HF

Reverse Voltage: 10 V

Forward Current: 100 mA

RoHS Device

Halogen Free

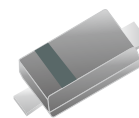

Features

- High speed switching.
- Small surface mounting type.
- Low forward voltage.

Mechanical data

- Case: SOD-523 standard package, molded plastic.
- Terminals: Tin plated leads, solderable per MIL-STD-202, method 208.
- Molding compound: UL flammability classification rating 94V-0.
- Polarity: Color band denotes cathode end.
- Mounting position: Any.

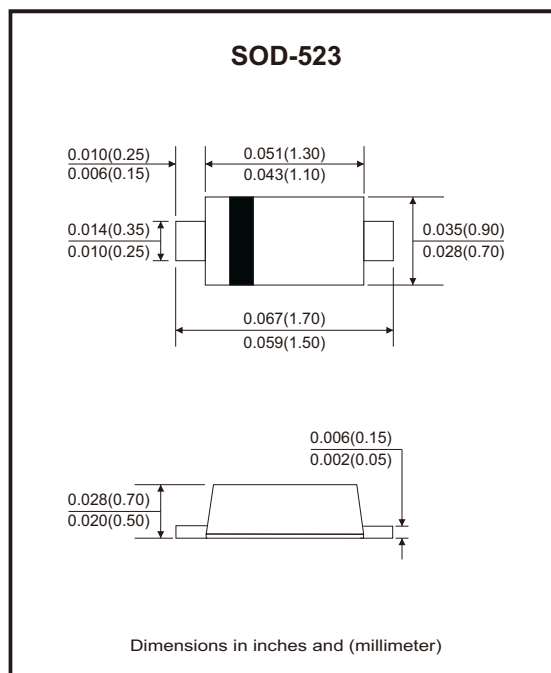

Circuit Diagram



Maximum Ratings (at TA=25°C, unless otherwise noted)

Parameter	Conditions	Symbol	Value	Unit
Peak reverse voltage		V_{RM}	15	V
DC reverse voltage		V_R	10	V
Maximum (peak) forward current		I_{FM}	200	mA
Continuous forward current		I_F	100	mA
Non-repetitive peak forward surge current	8.3ms single half sine-wave superimposed on rate load (JEDEC method)	I_{FSM}	1	A
Total power dissipation		P_{tot}	150	mW
Typical thermal resistance per leg (Note 1)		$R_{\theta JA}$	500	°C/W
Junction temperature		T_J	125	°C
Storage temperature range		T_{STG}	-55 to +125	°C
Operating temperature range		T_{opr}	-40 to +100	°C

Notes: 1. Part mounted on FR-4 board with recommended pad layout.

Electrical Characteristics (at TA=25°C, unless otherwise noted)

Parameter	Conditions	Symbol	Min.	Typ.	Max.	Unit
Reverse breakdown voltage	$I_R = 50\mu A$	$V_{(BR)R}$	10			V
Forward voltage	$I_F = 1mA$	V_F		0.18		V
	$I_F = 5mA$			0.23	0.30	
	$I_F = 100mA$			0.35	0.50	
Reverse current	$V_R = 10V$	I_R			20	μA
Diode capacitance	$V_R = 0V, f = 1MHz$	C_d		20	40	pF

Notes: 1.Pulse width $\leq 380\mu s$, duty cycle $< 2\%$.
 2.Pulse test, $t_p \leq 5ms$.

Rating and Characteristic Curves (1SS389-HF)

Fig.1 - Typical Reverse Characteristic

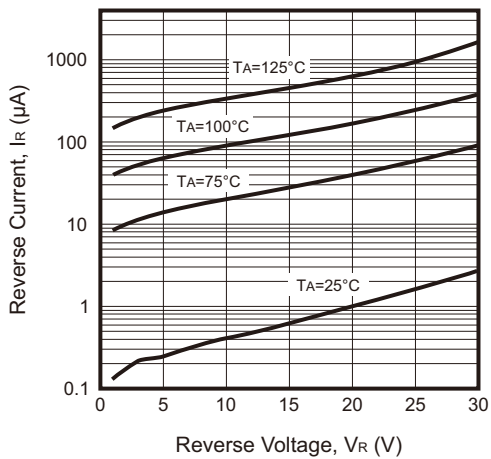

Fig.2 - Typical Forward Characteristic

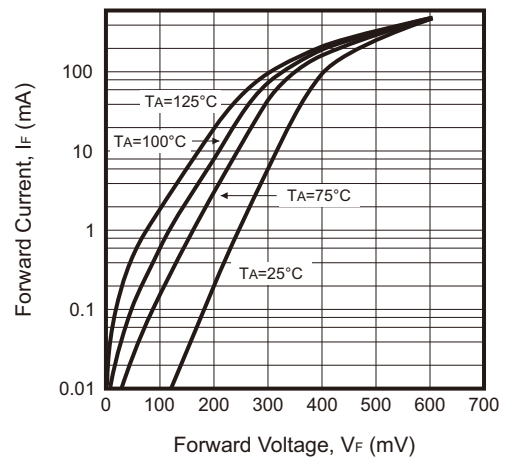

Fig.3 - Capacitance vs Reverse Voltage

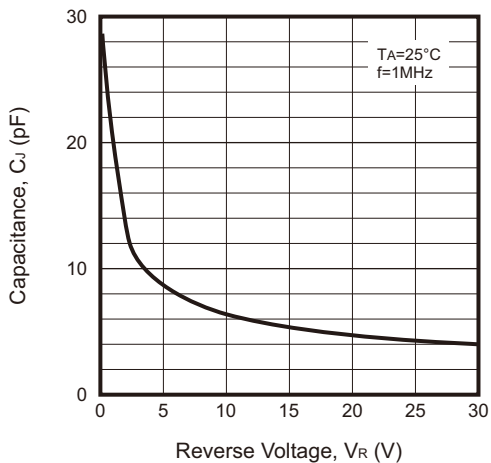
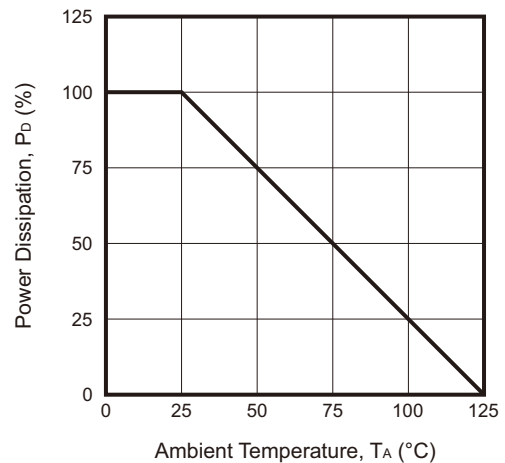
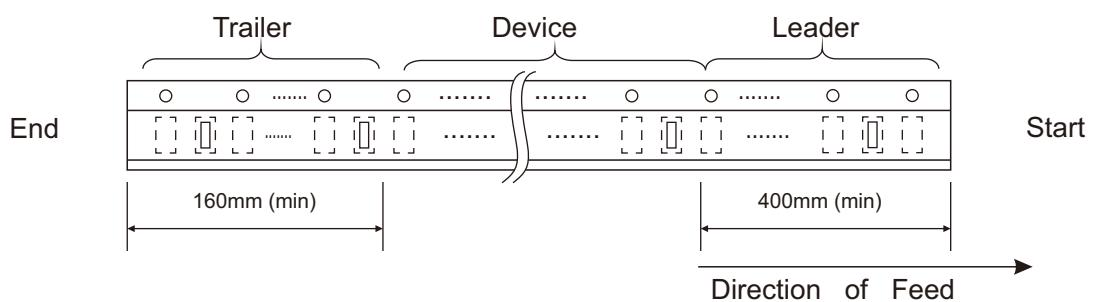
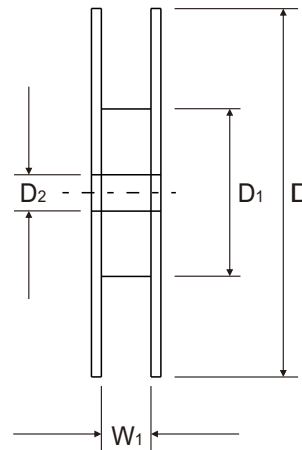
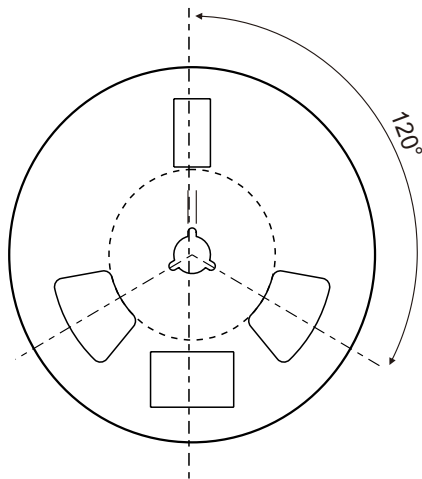
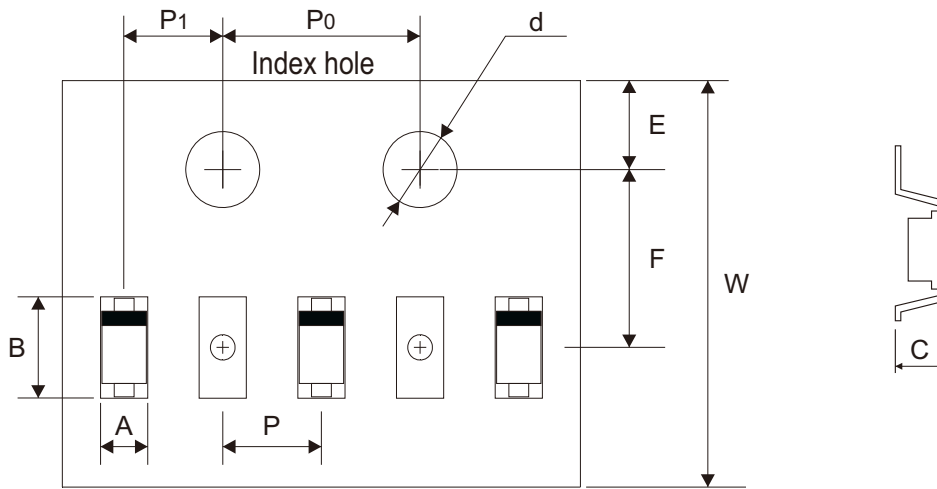

Fig.4 - Derating Curve (P_D - T_A)



Reel Taping Specification



SOD-523	SYMBOL	A	B	C	d	D	D ₁	D ₂
	(mm)	0.96 ± 0.05	1.94 ± 0.05	0.73 ± 0.05	1.50 + 0.10	178 ± 1.00	54.00 ± 0.50	13.00 ± 0.50
	(inch)	0.038 ± 0.002	0.076 ± 0.002	0.029 ± 0.002	0.059 + 0.004	7.008 ± 0.039	2.126 ± 0.020	0.512 ± 0.020

SOD-523	SYMBOL	E	F	P	P ₀	P ₁	W	W ₁
	(mm)	1.75 ± 0.10	3.50 ± 0.05	2.00 ± 0.05	4.00 ± 0.10	2.00 ± 0.05	8.00 + 0.30 - 0.10	9.50 ± 1.00
	(inch)	0.069 ± 0.004	0.138 ± 0.002	0.079 ± 0.002	0.157 ± 0.004	0.079 ± 0.002	0.315 + 0.012 - 0.004	0.374 ± 0.039

Marking Code

Part Number	Marking Code
1SS389-HF	S4

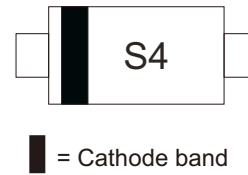

Suggested P.C.B. PAD Layout

SIZE	SOD-523	
	(mm)	(inch)
A	0.40	0.016
B	0.40	0.016
C	1.40	0.055

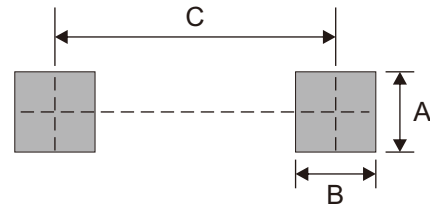

Standard Packaging

Case Type	REEL PACK	
	REEL (pcs)	Reel Size (inch)
SOD-523	3,000	7