

## SR540-HF Thru. SR5200-HF

Forward current: 5.0A  
Reverse voltage: 40 to 200V

RoHS Device  
Halogen Free

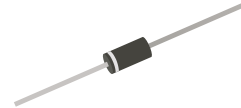

### Features

- Axial lead type devices for through hole design.
- Low power loss, high efficiency.
- High current capability, Low forward voltage drop.
- High surge capability.
- Guard ring for overvoltage protection.
- Ultra high-speed switching.
- Silicon epitaxial planar chip, metal silicon junction.
- Lead-free part meets environmental standards of MIL-STD-19500/228

### Mechanical Data

- Case: Molded plastic, DO-201AD/DO-27.
- Epoxy: UL94V-0 rate flame retardant.
- Lead: Axial lead, solderable per MIL-STD-202, Method 208 guaranteed.
- Polarity: color band denoted cathode end.
- Weight: 1.10 grams (approx.).

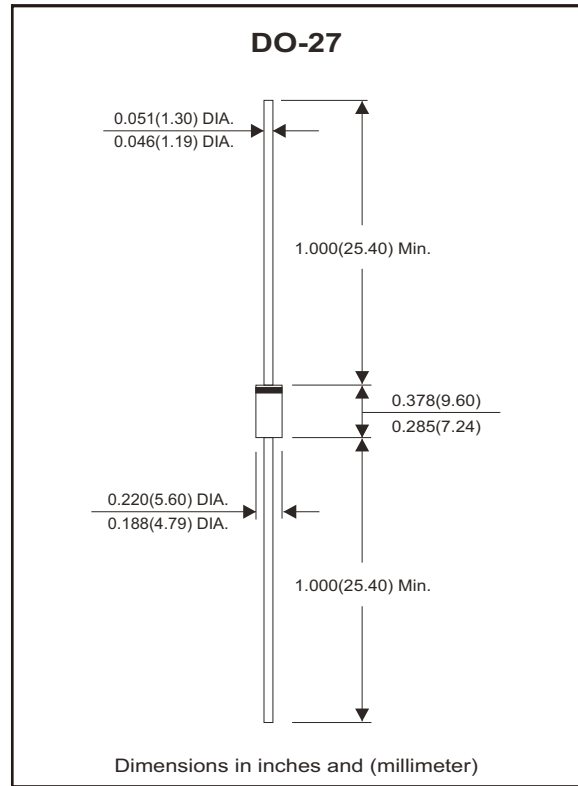

### Circuit Diagram



### Maximum Ratings and Electrical Characteristics

Ratings at  $T_a=25^{\circ}\text{C}$  unless otherwise noted.  
Single phase, half wave, 60Hz, resistive or inductive loaded.  
For capacitive load, derate current by 20% .

Parameter	Symbol	SR540-HF	SR560-HF	SR5100-HF	SR5150-HF	SR5200-HF	Unit
Maximum recurrent peak reverse voltage	$V_{RRM}$	40	60	100	150	200	V
Maximum RMS voltage	$V_{RMS}$	28	42	70	105	140	V
Maximum DC blocking voltage	$V_{DC}$	40	60	100	150	200	V
Maximum instantaneous forward voltage at $I_F=5A, T_A=25^{\circ}\text{C}$	$V_F$	0.55	0.75	0.81	0.87	0.90	V
Typical diode junction capacitance $f=1\text{MHz}$ and applied 4V DC reverse voltage	$C_J$	300					pF
Operating junction temperature range	$T_J$	-50 ~ +150			-50 ~ +175		$^{\circ}\text{C}$

Parameter	Conditions	Symbol	Min.	Typ.	Max.	Unit
Forward rectified current	See Fig.1	$I_o$			5.0	A
Forward surge current	8.3ms single half sine-wave superimposed on rate load (JEDEC method)	$I_{FSM}$			125	A
Reverse current	$V_R = V_{RRM} T_A=25^{\circ}\text{C}$	$I_R$			0.5	mA
	$V_R = V_{RRM} T_A=100^{\circ}\text{C}$	$I_R$			20	mA
Thermal resistance	Junction to ambient	$R_{\theta JA}$		24		$^{\circ}\text{C}/\text{W}$
Storage temperature range		$T_{STG}$	-50		+175	$^{\circ}\text{C}$

## Rating and Characteristic Curves (SR540-HF Thru. SR5200-HF)

Fig.1 - Typical Forward Current Derating Curve

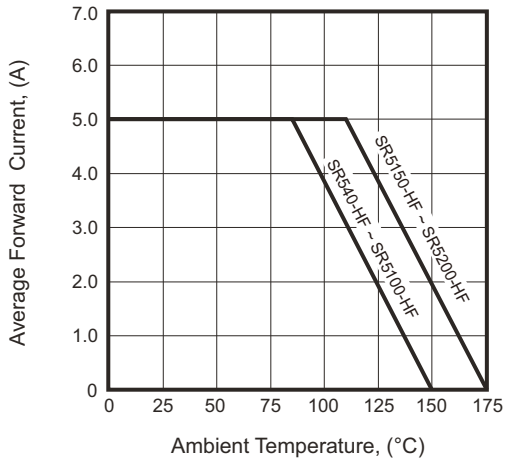

Fig.2 - Typical Forward Characteristics

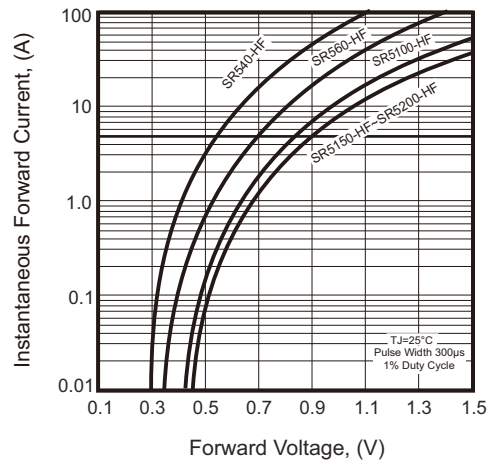

Fig.3 - Maximum Non-Repetitive Forward Surge Current

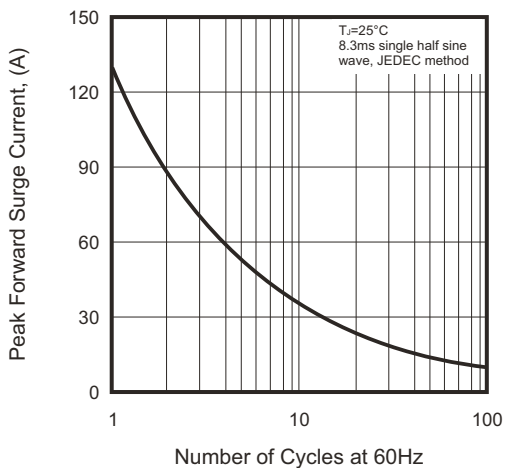

Fig.4 - Typical Junction Capacitance

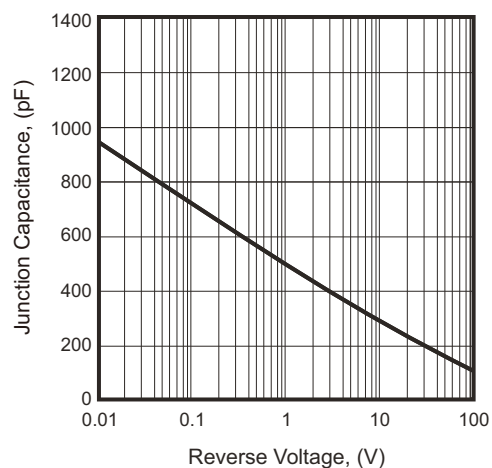
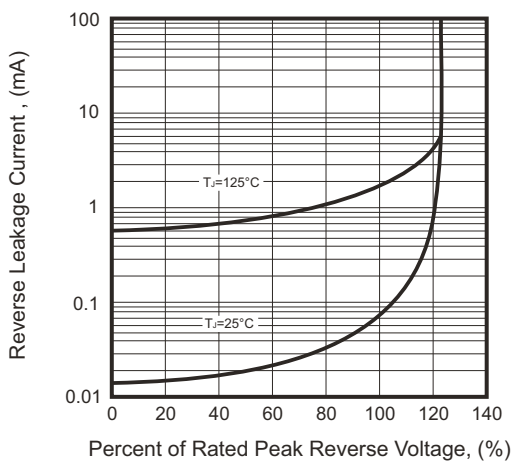
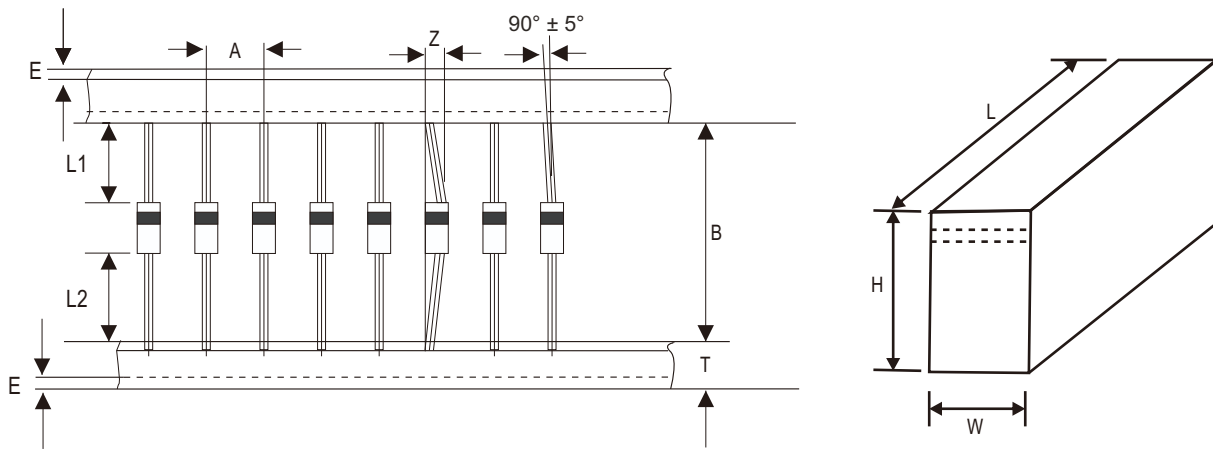

Fig.5 - Typical Reverse Characteristics



## Taping Specification For Axial Lead Diodes



DO-27	SYMBOL	A	B	Z	T	E
	(mm)	10.00 ± 0.50	52.40 (max)	1.60 (max)	6.00 ± 0.40	3.00 (max)
	(inch)	0.394 ± 0.020	2.063 (max)	0.062 (max)	0.236 ± 0.016	0.118 (max)

DO-27	SYMBOL	L1-L2	L	W	H
	(mm)	1.00(max)	260 ± 5.00	75 ± 5.00	145 ± 5.00
	(inch)	0.039(max)	10.236 ± 0.197	2.953 ± 0.197	5.709 ± 0.197

## Marking Code

Part Number	Marking Code
SR540-HF	SR54
SR560-HF	SR56
SR5100-HF	SR510
SR5150-HF	SR515
SR5200-HF	SR520

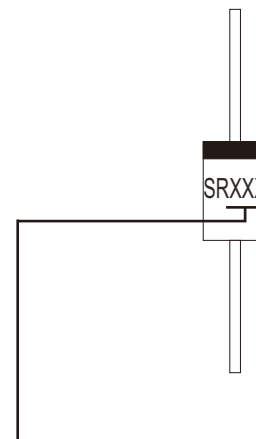

XX / XXX = Product type marking code

## Standard Packaging

Case Type	AMMO PACK	
	BOX ( pcs )	CARTON ( pcs )
DO-27	1,200	12,000