

S2A-HF Thru. S2M-HF

Reverse Voltage: 50 to 1000 Volts
 Forward Current: 2.0 Amp
 RoHS Device
 Halogen Free

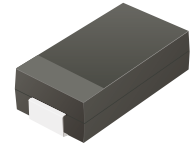

Features

- For surface mounted applications.
- Low profile package.
- Glass passivated chip junction.
- Easy to pick and place.

Mechanical data

- Case: SMA
- Terminals: Solderable per MIL-STD-750, method 2026.

Circuit Diagram

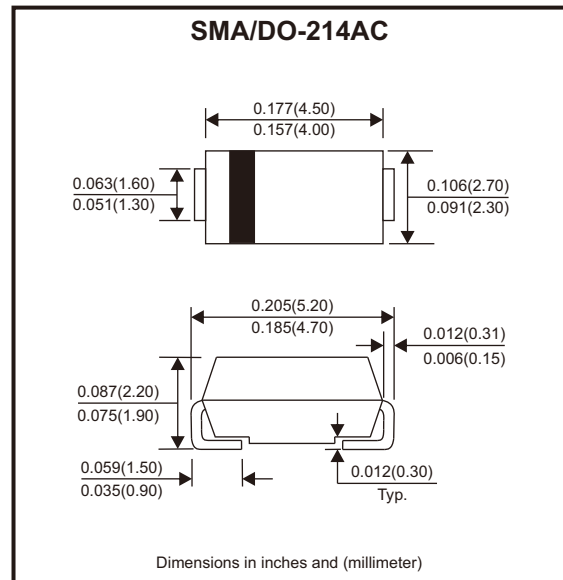

Maximum Ratings and Electrical Characteristics

Ratings at 25°C ambient temperature unless otherwise specified.
 Single phase, half wave, 60Hz resistive or inductive load, for capacitive load, derate by 20%

Parameter	Symbols	S2A-HF	S2B-HF	S2D-HF	S2G-HF	S2J-HF	S2K-HF	S2M-HF	Units
Maximum repetitive peak reverse voltage	V_{RRM}	50	100	200	400	600	800	1000	V
Maximum RMS voltage	V_{RMS}	35	70	140	280	420	560	700	V
Maximum DC blocking voltage	V_{DC}	50	100	200	400	600	800	1000	V
Maximum average forward rectified current	$I_{F(AV)}$	2							A
Peak forward surge current, 8.3ms single half sine-wave superimposed on rated load	I_{FSM}	50							A
Max instantaneous forward voltage at 2A	V_F	1.1							V
Maximum DC reverse current at rated DC blocking voltage	I_R	5 100							μA
Typical junction capacitance (Note 1)	C_j	25							pF
Typical thermal resistance (Note 2)	$R_{\theta JA}$	65							°C/W
Operating and storage temperature range	T_j, T_{stg}	-55 ~ +150							°C

Notes: 1. Measured at 1 MHz and applied reverse voltage of 4 V D.C
 2. P.C.B. mounted with 2.0" X 2.0" (5 X 5 cm) copper pad areas.

Company reserves the right to improve product design , functions and reliability without notice.

REV:A

Rating and Characteristic Curves (S2A-HF Thru. S2M-HF)

Fig.1 - Forward Current Derating Curve

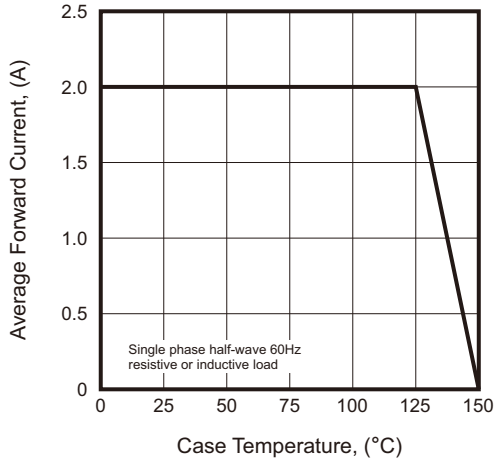

Fig.2 - Typical Reverse Characteristics

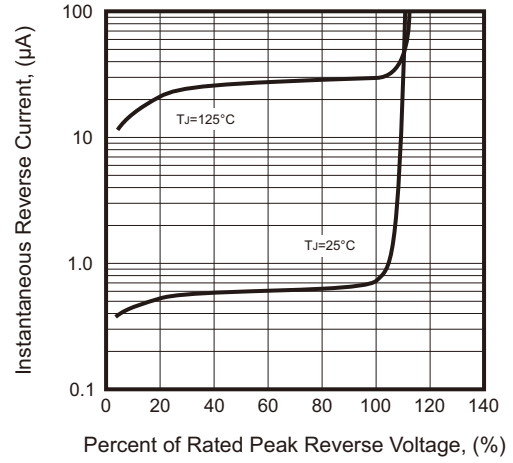

Fig.3 - Typical Forward Characteristic

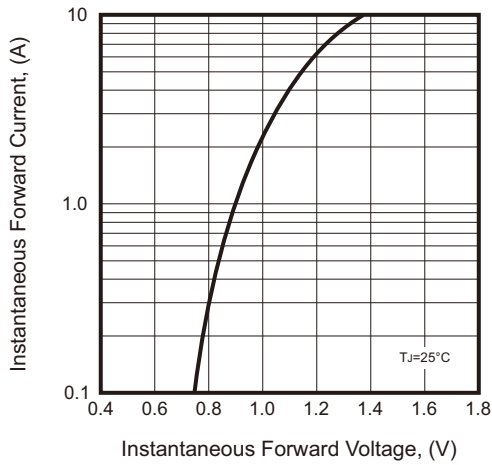

Fig.4 - Typical Junction Capacitance

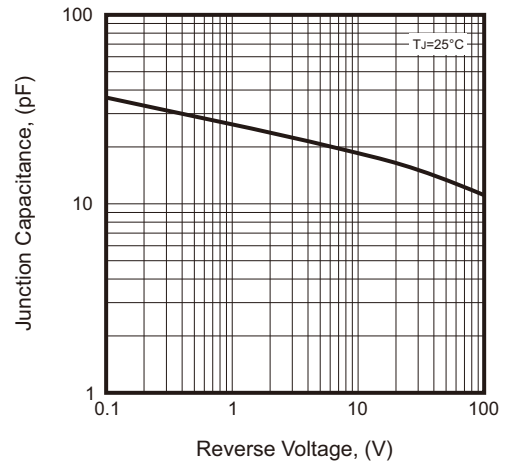
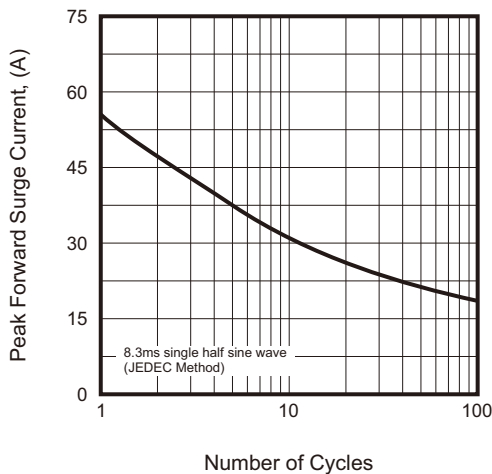
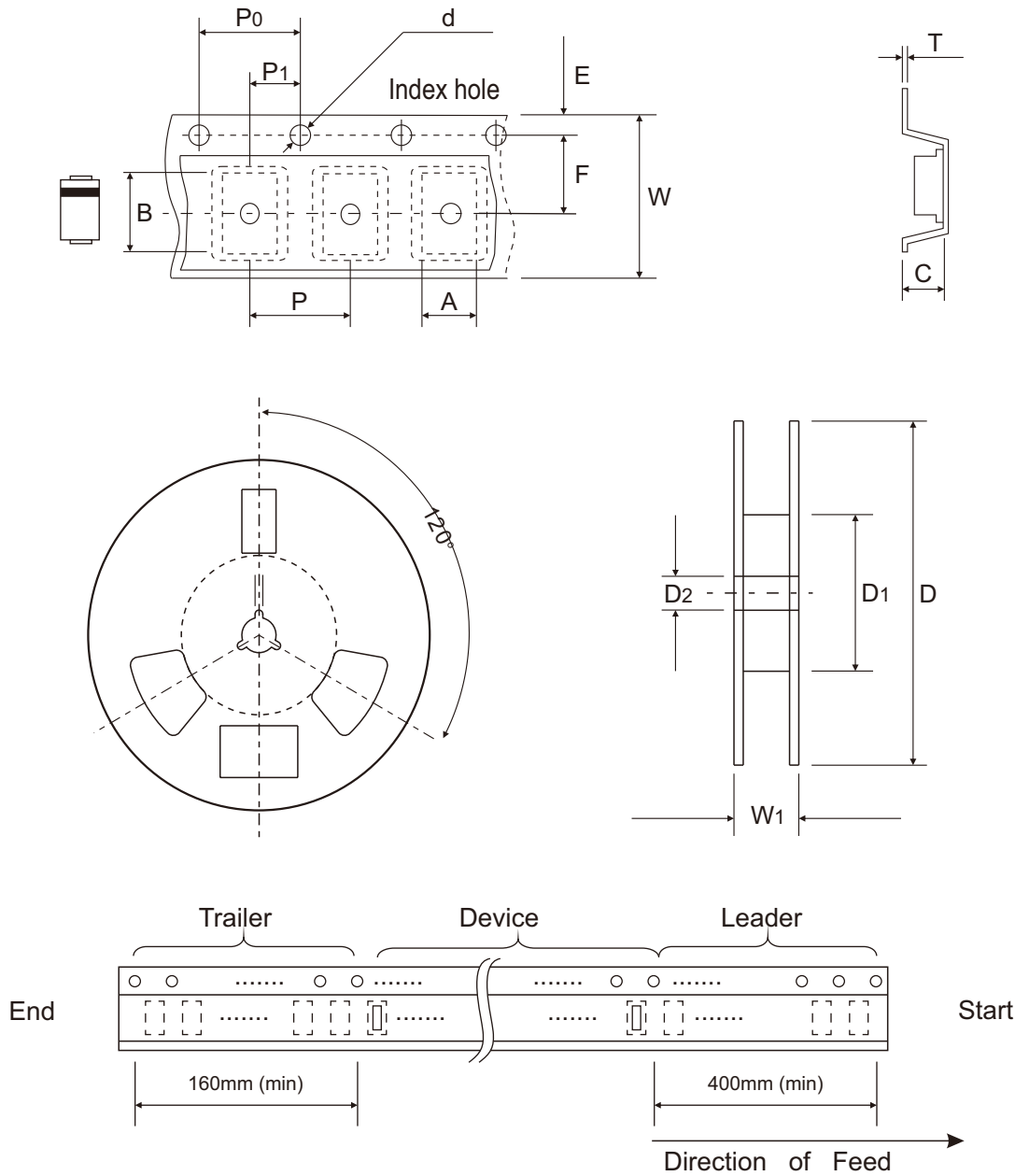

Fig.5 - Maximum Non-Repetitive Peak Forward Surge Current



Reel Taping Specification



DO-214AC (SMA)	SYMBOL	A	B	C	d	D	D1	D2
	(mm)	2.70 ± 0.10	5.33 ± 0.10	2.35 ± 0.10	1.55 ± 0.05	330 ± 2.00	75.00 ± 1.00	13.00 ± 0.20
	(inch)	0.106 ± 0.004	0.210 ± 0.004	0.093 ± 0.004	0.061 ± 0.002	12.992 ± 0.079	2.953 ± 0.039	0.512 ± 0.008

DO-214AC (SMA)	SYMBOL	E	F	P	P0	P1	T	W	W1
	(mm)	1.75 ± 0.10	5.50 ± 0.05	4.00 ± 0.10	4.00 ± 0.10	2.00 ± 0.10	0.20 ± 0.03	12.00 ± 0.30	14.70 + 2.00 - 1.00
	(inch)	0.069 ± 0.004	0.217 ± 0.002	0.157 ± 0.004	0.157 ± 0.004	0.079 ± 0.004	0.008 ± 0.001	0.472 ± 0.012	0.579 + 0.079 - 0.039

Company reserves the right to improve product design, functions and reliability without notice.

REV:A

Marking Code

Part Number	Marking Code
S2A-HF	S2A
S2B-HF	S2B
S2D-HF	S2D
S2G-HF	S2G
S2J-HF	S2J
S2K-HF	S2K
S2M-HF	S2M

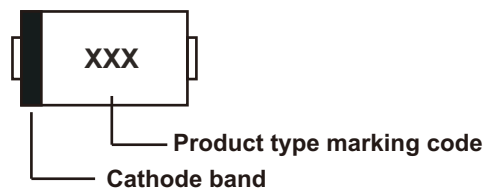

xxx = Product type marking code

Suggested PAD Layout

SIZE	DO-214AC (SMA)	
	(mm)	(inch)
A	2.40	0.094
B	1.80	0.071
C	1.80	0.071
D	6.00	0.236

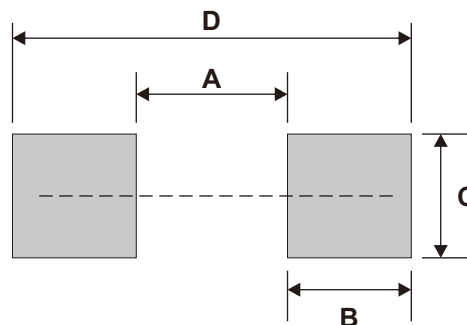

Note: 1. The pad layout is for reference purpose only.

Standard Packaging

Case Type	REEL PACK	
	REEL (pcs)	Reel Size (inch)
DO-214AC (SMA)	5,000	13