

CMS40N04V8-HF

**N-Channel
RoHS Device
Halogen Free**

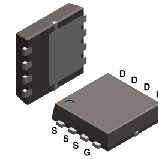

Features

- Super low gate charge.
- Green device available.
- Excellent C_{dv}/dt effect decline.
- Advanced high cell density trench technology.

Mechanical data

- Case: PDFN3x3-8L, molded plastic.
- Molding compound: UL flammability classification rating 94V-0.
- Terminals: Matte tin plated leads, solderability per MIL-STD-202, method 208.

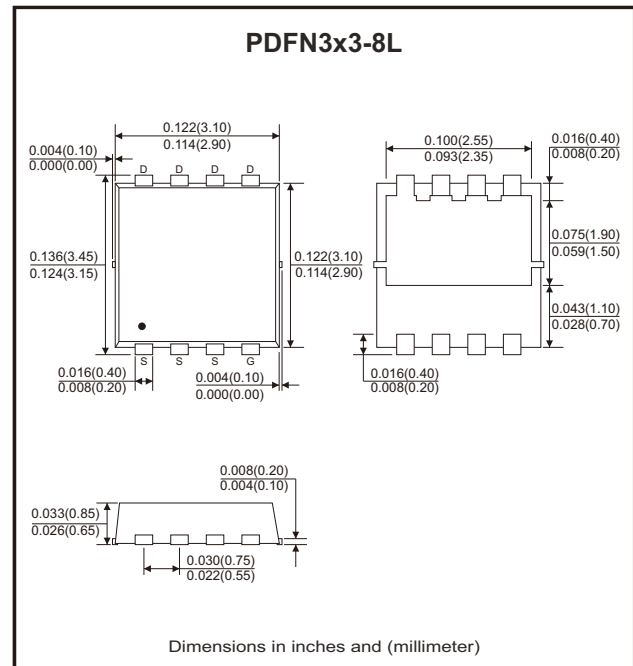

Circuit Diagram

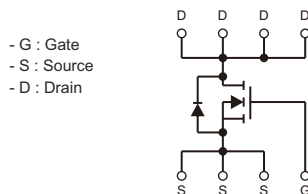

Maximum Ratings (at $T_A=25^\circ\text{C}$ unless otherwise noted)

Parameter	Symbol	Value	Unit
Drain-source voltage	V_{DSS}	40	V
Gate-source voltage	V_{GSS}	± 20	V
Continuous drain current ($T_C=25^\circ\text{C}$) (Note 1)	I_D	40	A
Continuous drain current ($T_C=100^\circ\text{C}$) (Note 1)	I_D	28	
Pulsed drain current (Note 2)	I_{DM}	120	A
Single pulse avalanche energy (Note 3)	E_{AS}	78	mJ
Power dissipation ($T_C=25^\circ\text{C}$)	P_D	25	W
Thermal resistance junction to case (Note 1)	$R_{\theta JC}$	5	$^\circ\text{C}/\text{W}$
Operating junction temperature range	T_J	-55 to +150	$^\circ\text{C}$
Storage temperature range	T_{STG}	-55 to +150	$^\circ\text{C}$

Electrical Characteristics (at $T_A=25^{\circ}\text{C}$ unless otherwise noted)

Parameter	Symbol	Conditions	Min	Typ	Max	Unit
Static Characteristics						
Drain-source breakdown voltage	V_{DSS}	$V_{GS} = 0V, I_D = 250\mu A$	40			V
Zero gate voltage drain current	I_{DSS}	$V_{DS} = 32V, V_{GS} = 0V, T_C = 25^{\circ}\text{C}$			1	μA
Gate-body leakage current	I_{GSS}	$V_{GS} = \pm 20V, V_{DS} = 0V$			± 100	nA
On Characteristics						
Static drain-source on-resistance (Note 2)	$R_{DS(on)}$	$V_{GS} = 10V, I_D = 12A$			8	m Ω
	$R_{DS(on)}$	$V_{GS} = 4.5V, I_D = 10A$			10	m Ω
Gate threshold voltage	$V_{GS(th)}$	$V_{DS} = V_{GS}, I_D = 250\mu A$	1.2		2.5	V
Dynamic Characteristics						
Input capacitance	C_{iss}	$V_{GS} = 0V, V_{DS} = 15V, f = 1\text{MHz}$		2332		pF
Output capacitance	C_{oss}			193		
Reverse transfer capacitance	C_{rss}			138		
Switching Characteristics						
Turn-on delay time	$t_{d(on)}$	$V_{DD} = 15V, V_{GS} = 10V, R_G = 3.3\Omega, I_D = 1A$		14.3		ns
Turn-on rise time	t_r			2.6		
Turn-off delay time	$t_{d(off)}$			77		
Turn-off fall time	t_f			4.8		
Total gate charge	Q_g	$V_{DD} = 20V, V_{GS} = 4.5V, I_D = 20A$		18.8		nC
Gate to source charge	Q_{gs}			4.7		
Gate to drain (miller) charge	Q_{gd}			8.2		
Source-Drain Diode Characteristics						
Diode forward voltage (Note 2)	V_{SD}	$I_{SD} = 1A, V_{GS} = 0V, T_J = 25^{\circ}\text{C}$			1.2	V
Drain continuous forward current (Note 1, 4)	I_S				70	A
Pulsed source drain current (Note 2, 4)	I_{SM}				50	A

Notes: 1. The data tested by surface mounted on 1 inch² FR-4 board with 2oz cooper.

2. The data tested by pulsed, pulse width $\leq 300\mu s$, duty cycle $\leq 2\%$.

3. The EAS data shows Max. rating. The test condition is $V_{DD}=25V, V_{GS}=10V, L=0.5mH$.

4. The data is theoretically the same as I_D and I_{DM} , in real applications, should be limited by total power dissipation.

Rating and Characteristic Curves (CMS40N04V8-HF)

Fig.1 - Typical Output Characteristics

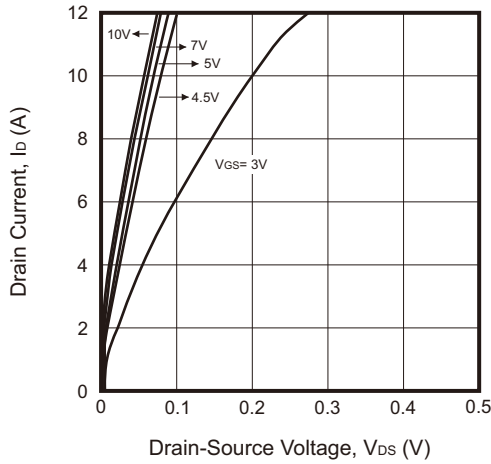

Fig.2 - Maximum Safe Operating Area

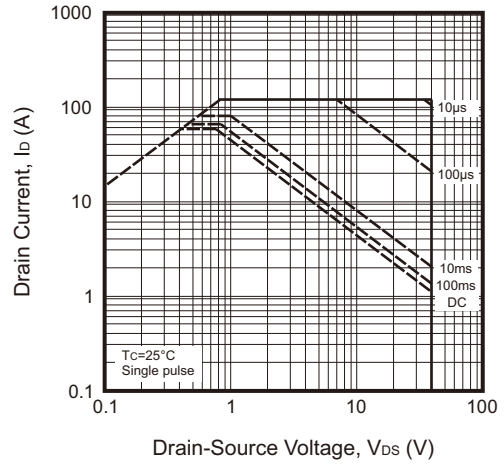

Fig.3 - On-Resistance vs. Gate-Source Voltage

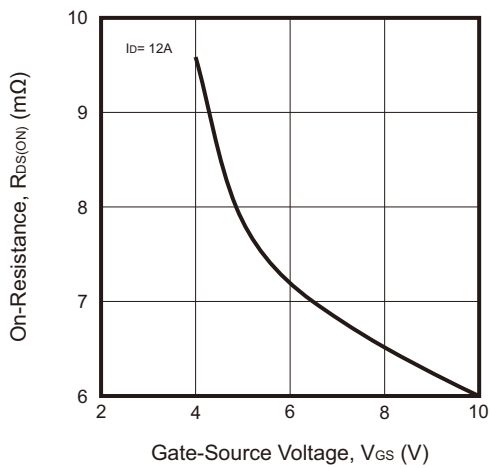

Fig.4 - Body-Diode Characteristics

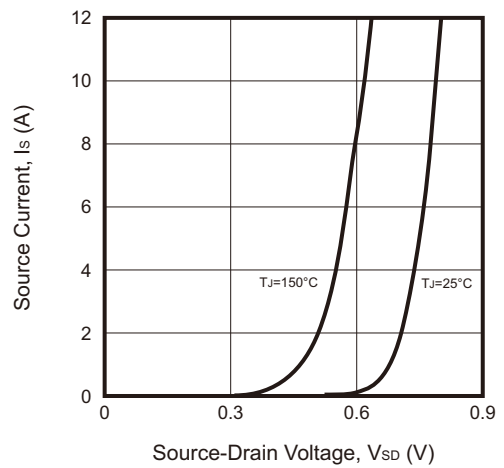

Fig.5 - On-Resistance vs. Junction Temperature

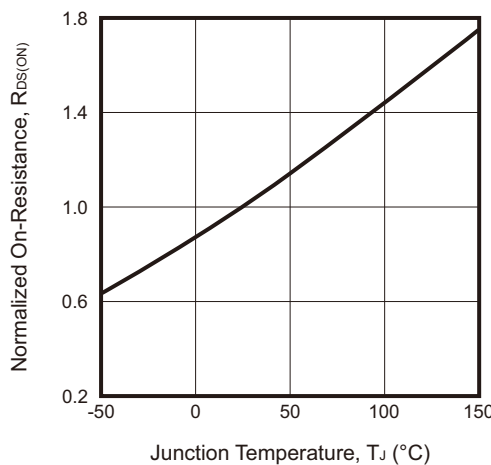
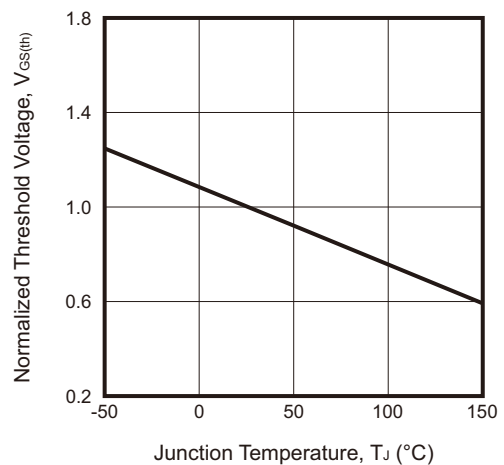

Fig.6 - $V_{GS(th)}$ vs. Junction Temperature



Rating and Characteristic Curves (CMS40N04V8-HF)

Fig.7 - Capacitance Characteristics

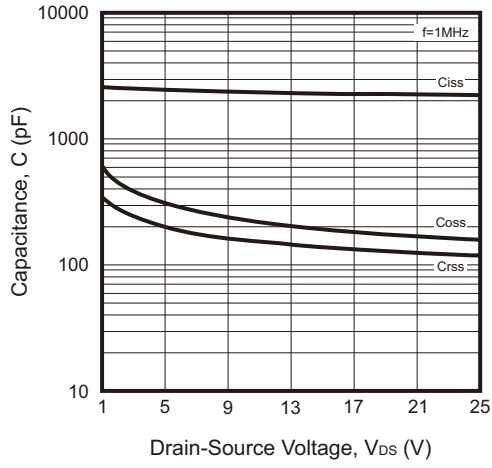
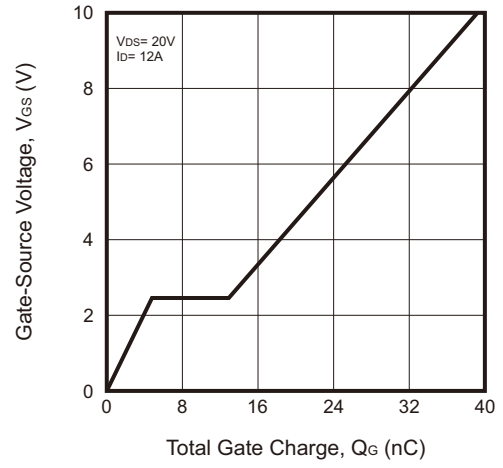
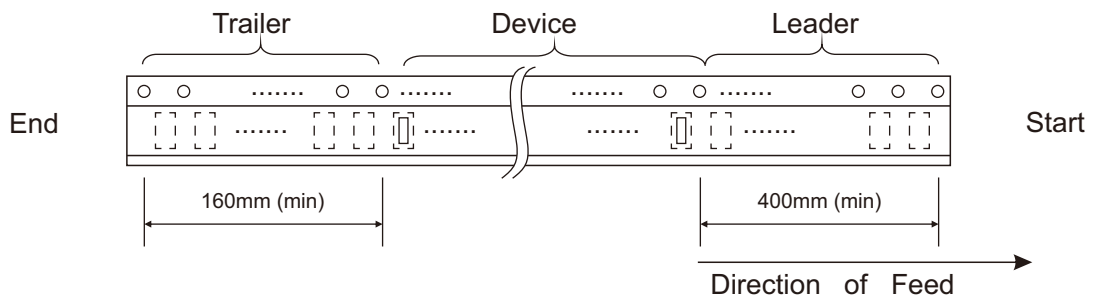
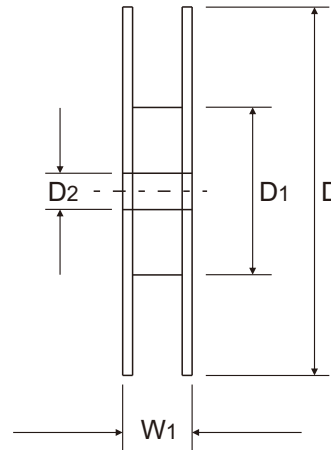
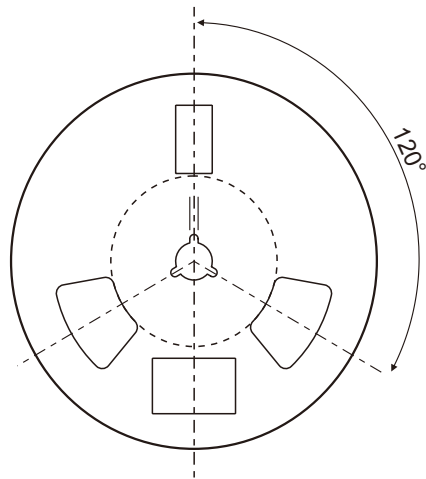
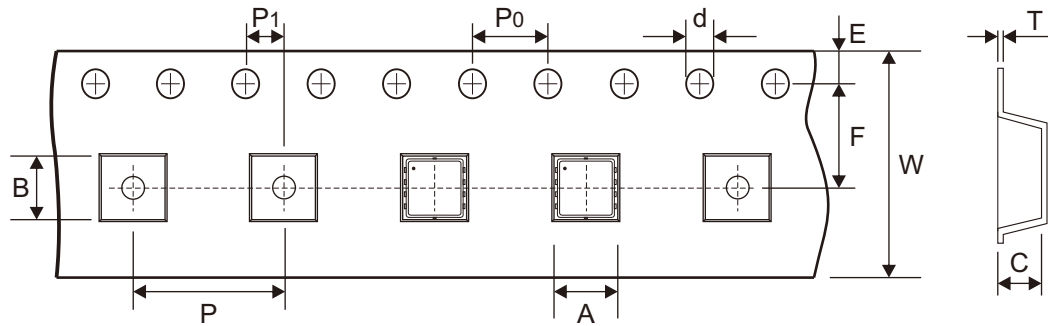

Fig.8 - Gate-Charge Characteristics



Reel Taping Specification



PDFN3x3-8L	SYMBOL	A	B	C	d	D	D1	D2
	(mm)	3.60 ± 0.10	3.60 ± 0.10	1.20 ± 0.10	1.50 + 0.10 - 0.00	330 ± 1.00	100 ± 1.00	13.00 ± 0.20
	(inch)	0.142 ± 0.004	0.142 ± 0.004	0.047 ± 0.004	0.059 + 0.004 - 0.000	12.992 ± 0.039	3.937 ± 0.039	0.512 ± 0.008

PDFN3x3-8L	SYMBOL	E	F	P	P0	P1	T	W	W1
	(mm)	1.75 ± 0.10	5.50 ± 0.05	8.00 ± 0.10	4.00 ± 0.10	2.00 ± 0.05	0.25 ± 0.02	12.00 + 0.30 - 0.10	17.80 ± 0.30
	(inch)	0.069 ± 0.004	0.217 ± 0.002	0.315 ± 0.004	0.157 ± 0.004	0.079 ± 0.002	0.010 ± 0.001	0.472 + 0.012 - 0.004	0.701 ± 0.012

Marking Code

Part Number	Marking Code
CMS40N04V8-HF	080N04

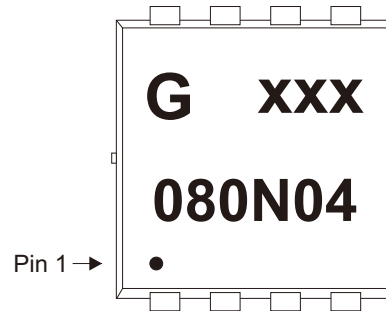

XXX = Control code

Suggested P.C.B. PAD Layout

SIZE	PDFN3x3-8L	
	(mm)	(inch)
A	0.42	0.017
B	0.70	0.028
C	0.65	0.026
D	2.25	0.089
E	2.37	0.093
F	0.42	0.017
G	0.23	0.009
H	1.85	0.073
I	3.70	0.146

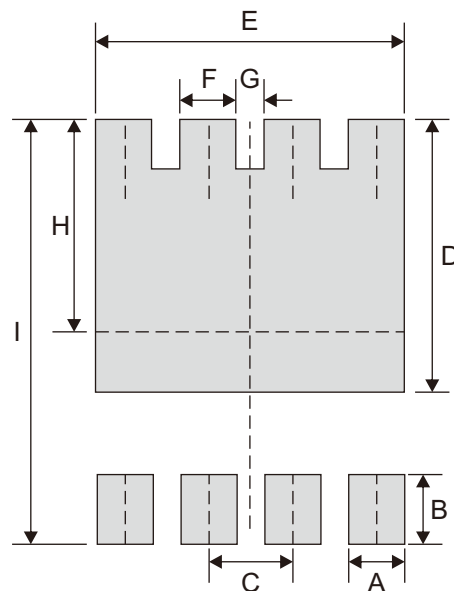

Standard Packaging

Case Type	REEL PACK	
	REEL (pcs)	Reel Size (inch)
PDFN3x3-8L	5,000	13