

## BC817-16-HF/25-HF/40-HF (NPN)

RoHS Device

Halogen Free

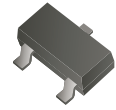

### Features

- For general AF applications.
- High collector current.
- High current gain.
- Low collector-emitter saturation voltage.

### Mechanical data

- Case: SOT-23, molded plastic.
- Terminals: Solderable per MIL-STD-750, method 2026.
- Weight: 0.0078 grams(approx.).

### Circuit Diagram

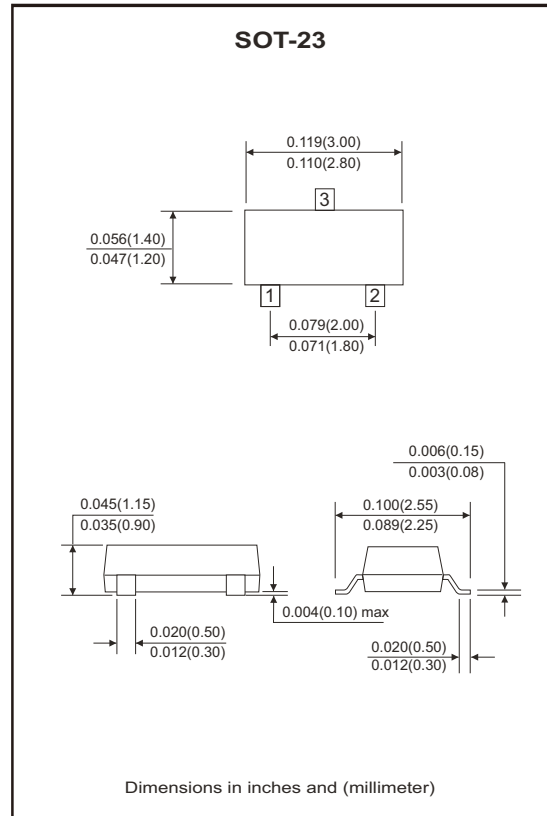
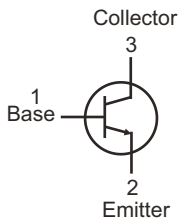

### Maximum Ratings (at $T_A=25^\circ\text{C}$ unless otherwise noted)

Parameter	Symbol	Value	Unit
Collector-Base voltage	$V_{CBO}$	50	V
Collector-Emitter voltage	$V_{CEO}$	45	V
Emitter-Base voltage	$V_{EBO}$	5	V
Collector current-continuous	$I_C$	500	mA
Collector power dissipation	$P_C$	300	mW
Thermal resistance from junction to ambient	$R_{\theta JA}$	417	$^\circ\text{C}/\text{W}$
Junction temperature range	$T_J$	150	$^\circ\text{C}$
Storage temperature range	$T_{STG}$	-55 to +150	$^\circ\text{C}$

## Electrical Characteristics (at TA=25°C unless otherwise noted)

Parameter	Symbol	Conditions	Min	Typ	Max	Unit
Collector-Base breakdown voltage	$V_{(BR)CBO}$	$I_C = 10\mu A, I_E = 0$	50			V
Collector-Emitter breakdown voltage	$V_{(BR)CEO}$	$I_C = 10mA, I_B = 0$	45			V
Emitter-Base breakdown voltage	$V_{(BR)EBO}$	$I_E = 1\mu A, I_C = 0$	5			V
Collector cut-off current	$I_{CBO}$	$V_{CB} = 45V, I_E = 0$			0.1	$\mu A$
Emitter cut-off current	$I_{EBO}$	$V_{EB} = 4V, I_C = 0$			0.1	$\mu A$
DC current gain	$h_{FE(1)}$	$V_{CE} = 1V, I_C = 100mA$	100		600	
	$h_{FE(2)}$	$V_{CE} = 1V, I_C = 500mA$	40			
Collector-Emitter saturation voltage	$V_{CE(SAT)}$	$I_C = 500mA, I_B = 50mA$			0.7	V
Base-Emitter saturation voltage	$V_{BE(SAT)}$	$I_C = 500mA, I_B = 50mA$			1.2	V
Base-Emitter voltage	$V_{BE(ON)}$	$V_{CE} = 1V, I_C = 500mA$			1.2	V
Collector capacitance	$C_{ob}$	$V_{CB} = 10V, f = 10MHz$		10		pF
Transition frequency	$f_T$	$V_{CE} = 5V, I_C = 10mA, f = 100MHz$	100			MHz

## Classification of $h_{FE(1)}$

Rank	BC817-16-HF	BC817-25-HF	BC817-40-HF
Range	100-250	160-400	250-600

## Rating and Characteristic Curves (BC817-16-HF/25-HF/40-HF)

Fig.1 - Static Characteristic

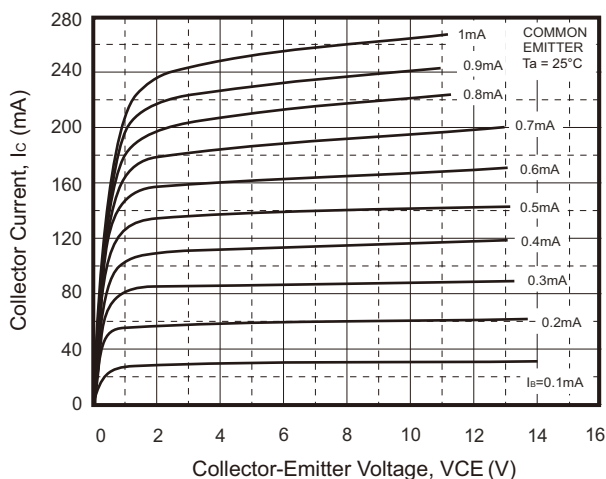
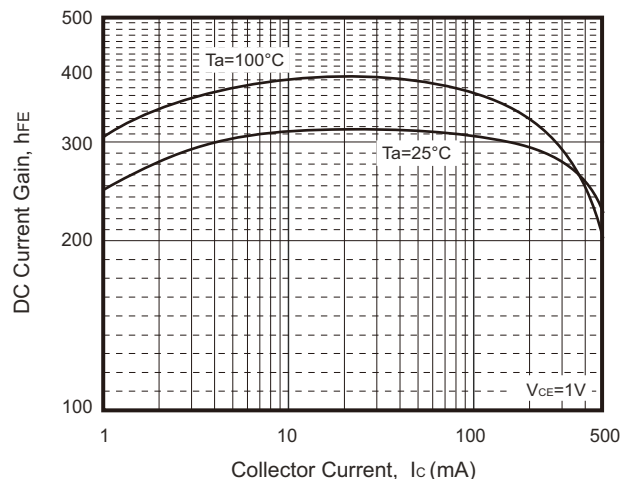

Fig.2 -  $h_{FE} - I_C$



## Rating and Characteristic Curves (BC817-16-HF/25-HF/40-HF)

Fig.3 -  $V_{BEsat} - I_C$

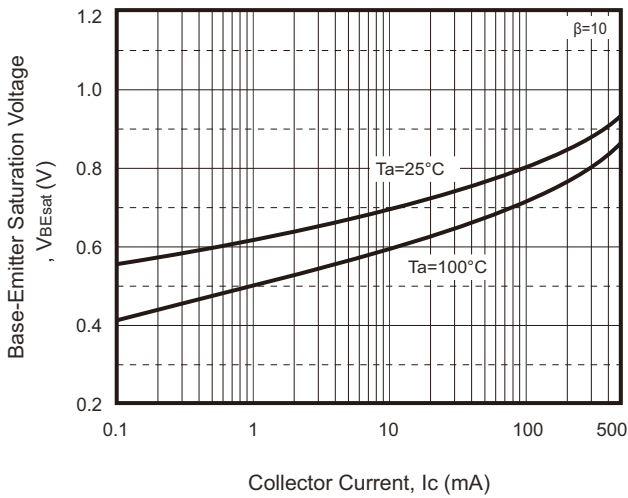

Fig.4 -  $V_{CEsat} - I_C$

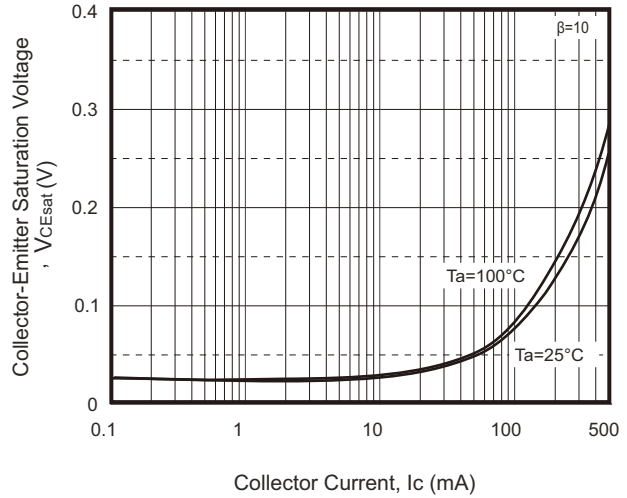

Fig.5 -  $I_C - V_{BE}$

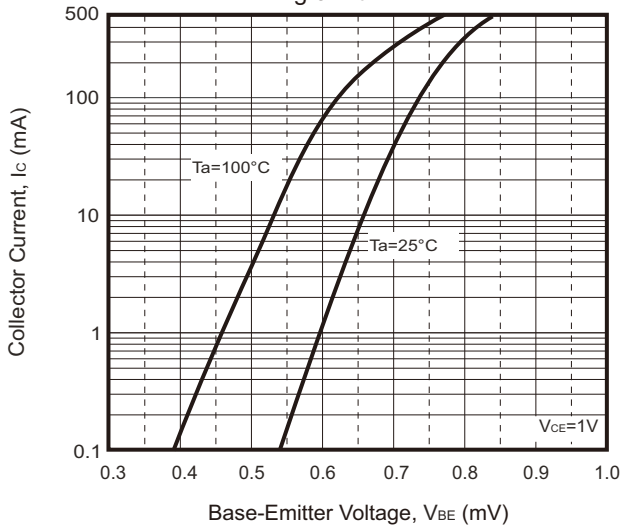

Fig.6 -  $C_{ob}/C_{ib} - V_{CB}/V_{EB}$

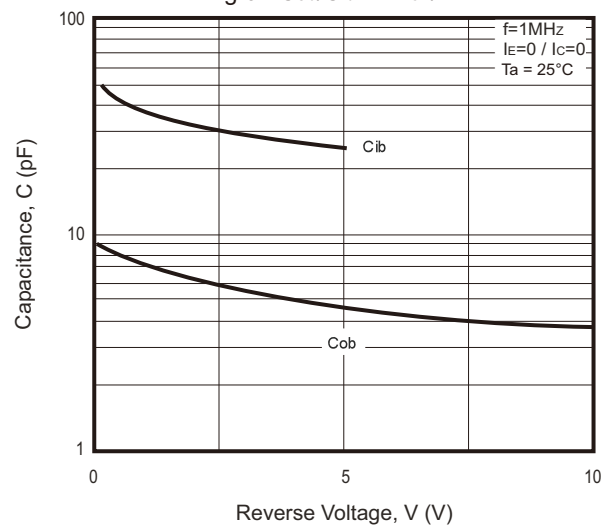

Fig.7 -  $f_T - I_C$

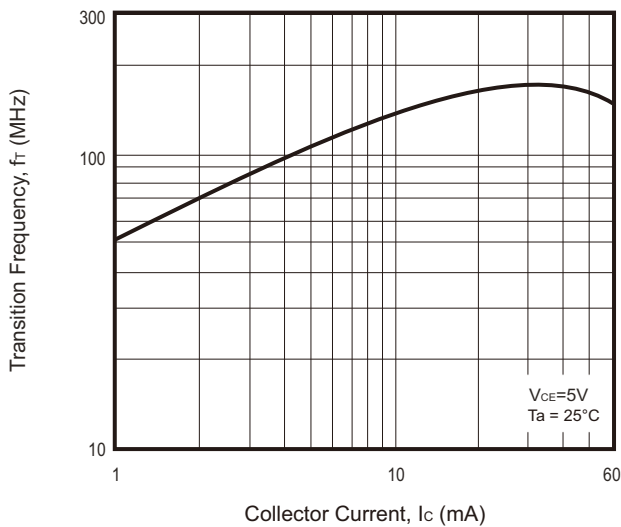
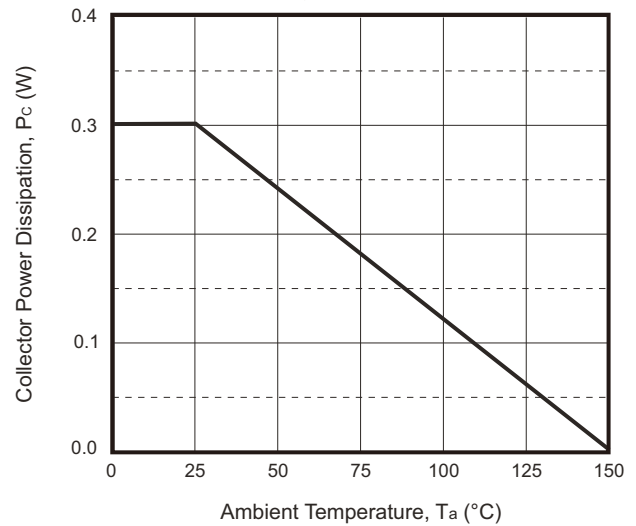
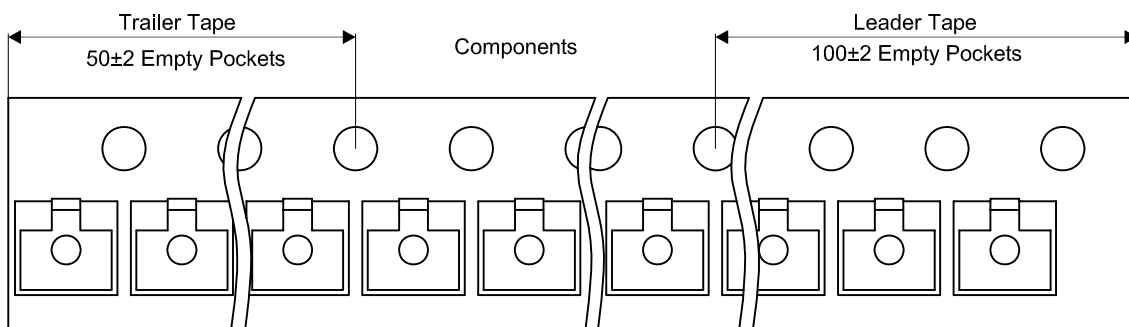
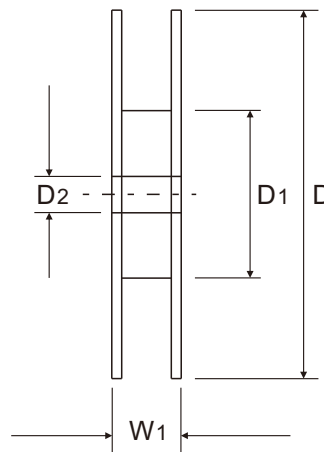
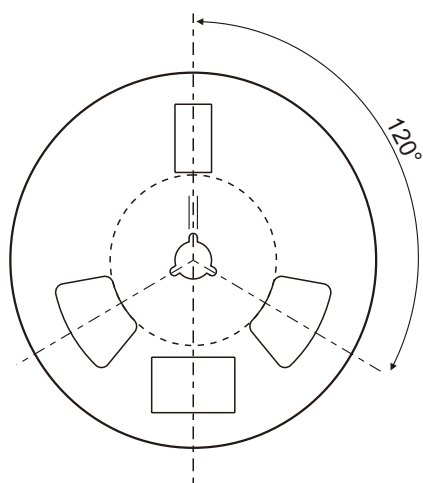
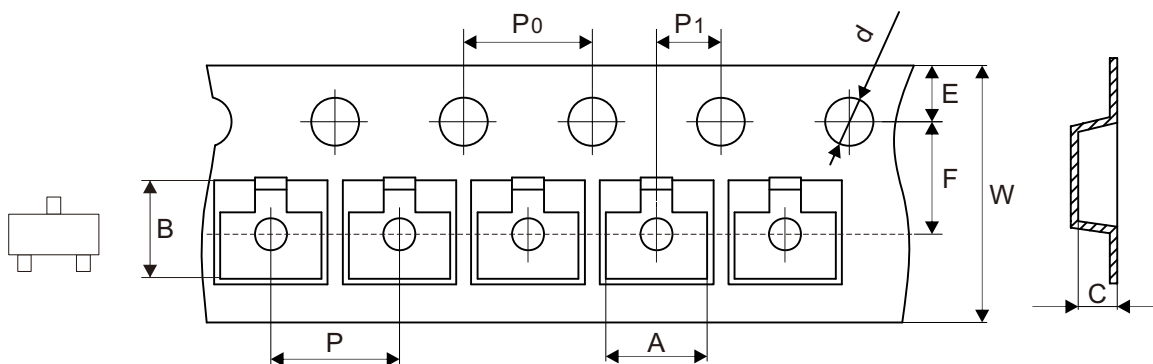

Fig.8 -  $P_C - T_a$



## Reel Taping Specification



SOT-23	SYMBOL	A	B	C	d	D	D1	D2
	(mm)	3.15 ± 0.10	2.77 ± 0.10	1.22 ± 0.10	1.50 ± 0.10	178.00 ± 2.00	54.40 ± 1.00	13.00 ± 1.00
	(inch)	0.124 ± 0.004	0.109 ± 0.004	0.048 ± 0.004	0.059 ± 0.004	7.008 ± 0.079	2.142 ± 0.039	0.512 ± 0.039

SOT-23	SYMBOL	E	F	P	P0	P1	W	W1
	(mm)	1.75 ± 0.10	3.50 ± 0.10	4.00 ± 0.10	4.00 ± 0.10	2.00 ± 0.10	8.00 + 0.30 - 0.10	12.30 ± 1.00
	(inch)	0.069 ± 0.004	0.138 ± 0.004	0.157 ± 0.004	0.157 ± 0.004	0.079 ± 0.004	0.315 + 0.012 - 0.004	0.484 ± 0.039

## Marking Code

Part Number	Marking Code
BC817-16-HF	6A
BC817-25-HF	6B
BC817-40-HF	6C

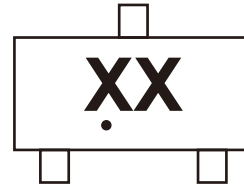

Solid dot = Control code  
 xx = Product type marking code

## Suggested P.C.B. PAD Layout

SIZE	SOT-23	
	(mm)	(inch)
A	0.80	0.031
B	0.60	0.024
C	1.90	0.075
D	2.02	0.080
E	2.82	0.111

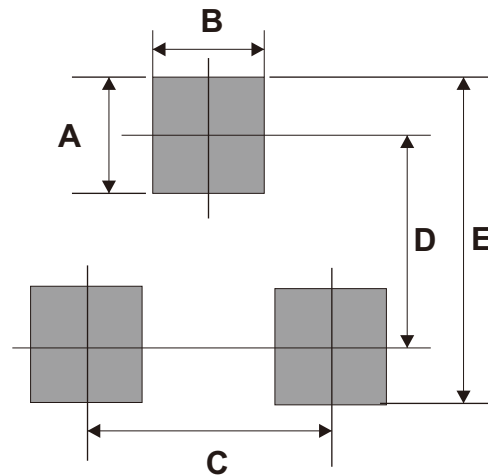

## Standard Packaging

Case Type	REEL PACK	
	REEL (pcs)	Reel Size (inch)
SOT-23	3,000	7