

CMS07N06V8-HF

**N-Channel
RoHS Device
Halogen Free**

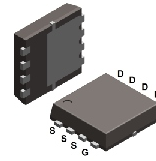

Features

- High-speed switching.

Mechanical data

- Case: PDFN3x3-8L, molded plastic.
- Molding compound: UL flammability classification rating 94V-0.
- Terminals: Matte tin plated leads, solderability per MIL-STD-202, method 208.

Circuit Diagram

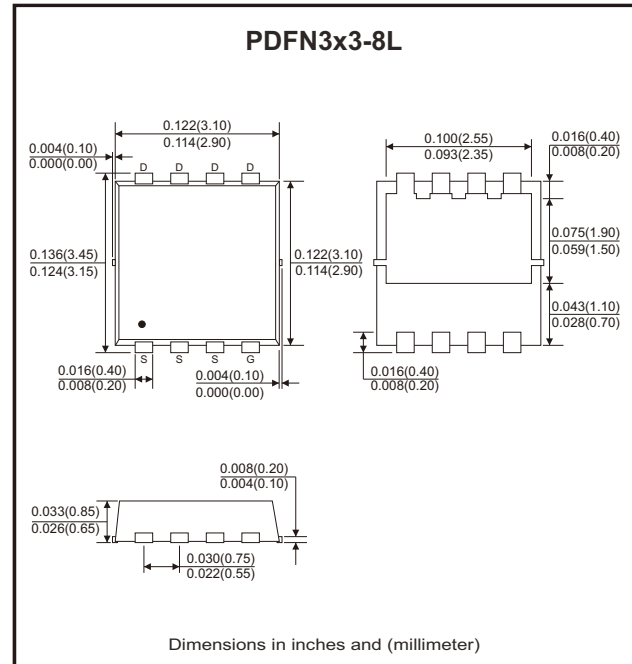
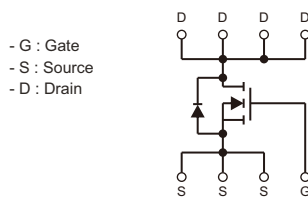

Maximum Ratings (at TA=25°C unless otherwise noted)

Parameter	Symbol	Value	Unit
Drain-source voltage	V_{DS}	60	V
Gate-source voltage	V_{GS}	±20	V
Continuous drain current (T _C =25°C)	I_D	21	A
Continuous drain current (T _C =100°C)	I_D	13	
Continuous drain current (T _A =25°C) (Note 1)	I_D	7.2	
Continuous drain current (T _A =100°C) (Note 1)	I_D	4.5	
Pulsed drain current (tp=10µs, T _C =25°C)	I_{DM}	84	A
Pulsed drain current (tp=10µs, T _A =25°C)	I_{DM}	60	A
Single pulse avalanche energy (Note 3)	E_{AS}	6	mJ
Power dissipation (T _C =25°C)	P_D	18	W
Power dissipation (T _A =25°C) (Note 1)	P_D	2	W
Operating junction temperature range	T_J	-55 to +150	°C
Storage temperature range	T_{STG}	-55 to +150	°C

Thermal Characteristics

Parameter	Symbol	Min	Typ	Max	Unit
Thermal resistance junction to case	$R_{\theta JC}$			7	°C/W
Thermal resistance junction to air (Note 1)	$R_{\theta JA}$		54	60	°C/W

Electrical Characteristics (at $T_J=25^\circ\text{C}$ unless otherwise noted)

Parameter	Symbol	Conditions	Min	Typ	Max	Unit
Static Characteristics						
Drain-source breakdown voltage	V_{DS}	$V_{GS} = 0V, I_D = 250\mu A$	60			V
Zero gate voltage drain current	I_{DSS}	$V_{DS} = 60V, V_{GS} = 0V$			1	μA
Gate-body leakage current	I_{GSS}	$V_{GS} = \pm 20V, V_{DS} = 0V$			± 100	nA
On Characteristics						
Drain-source on-resistance (Note 2)	$R_{DS(on)}$	$V_{GS} = 10V, I_D = 10A$		21	25	m Ω
	$R_{DS(on)}$	$V_{GS} = 4.5V, I_D = 10A$		27	35	m Ω
Gate threshold voltage	$V_{GS(th)}$	$V_{DS} = V_{GS}, I_D = 250\mu A$	1	1.5	3	V
Gate resistance	R_G	$V_{GS} = 0V, f = 1MHz$		3.8		Ω
Dynamic Characteristics						
Input capacitance	C_{iss}	$V_{GS} = 0V, V_{DS} = 25V, f = 1MHz$		570		pF
Output capacitance	C_{oss}			186		
Reverse transfer capacitance	C_{rss}			23		
Switching Characteristics						
Turn-on delay time	$t_{d(on)}$	$V_{DD} = 30V, V_{GS} = 15V, I_D = 15A$ $R_G = 3.3\Omega$		3		ns
Turn-on rise time	t_r			37		
Turn-off delay time	$t_{d(off)}$			14		
Turn-off fall time	t_f			30		
Total gate charge	Q_g	$V_{DD} = 30V, V_{GS} = 10V, I_D = 10A$		14.5		nC
Gate to source charge	Q_{gs}			2.6		
Gate to drain (miller) charge	Q_{gd}			2.9		
Source-Drain Diode Characteristics						
Diode forward voltage (Note 2)	V_{SD}	$I_{SD} = 10A, V_{GS} = 0V, T_J = 25^\circ\text{C}$		0.9	1.2	V
Reverse recovery time	t_{rr}	$V_R = 30V, I_F = 10A, di/dt = 100A/\mu s$		24.8		ns
Reverse recovery charge	Q_{rr}			15.7		nC

Notes: 1. The data tested by surface mounted on a 1 inch² FR-4 board with 2OZ copper.

2. The data tested by pulsed, pulse width $\leq 300\mu s$, duty cycle $\leq 2\%$.

3. The EAS data shows max. rating. The test condition is $V_{DD}=30V, V_{GS}=10V, L=0.5mH$.

Typical Rating and Characteristic Curves (CMS07N06V8-HF)

Fig.1 - Power Dissipation

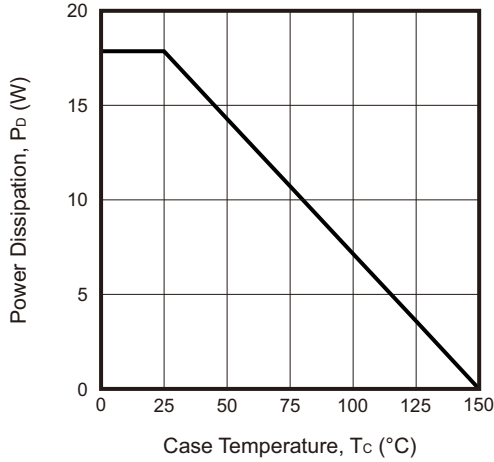

Fig.2 - Drain Current

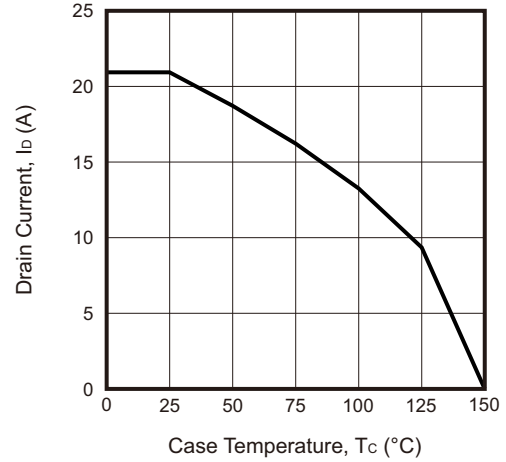

Fig.3 - Typical Output Characteristics

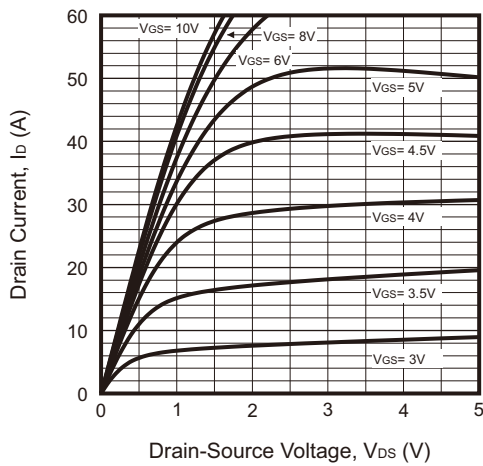

Fig.4 - On-Resistance vs. Drain Current and Gate Voltage

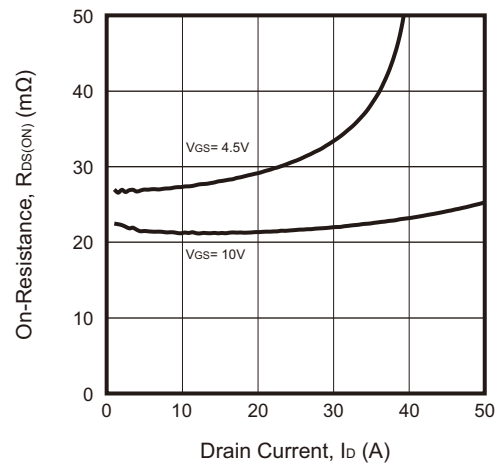

Fig.5 - On-Resistance vs. Gate-Source Voltage

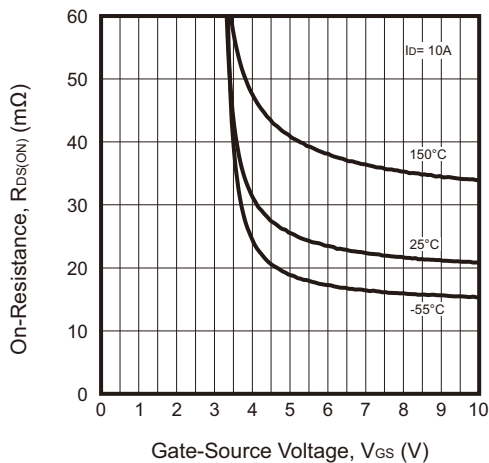
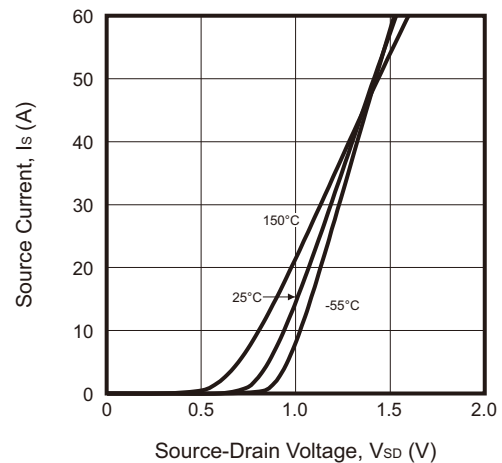
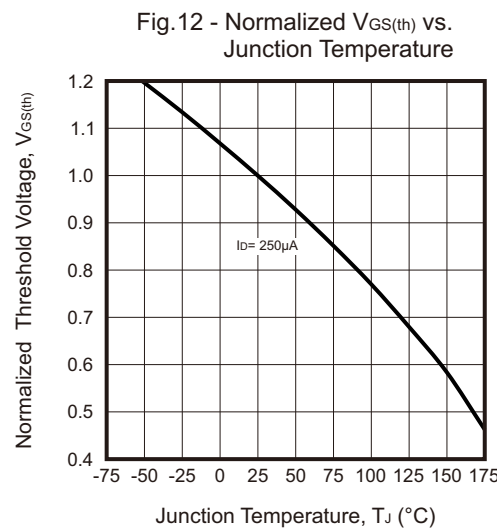
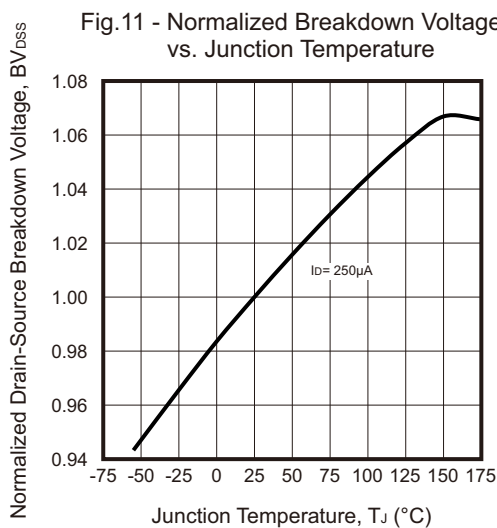
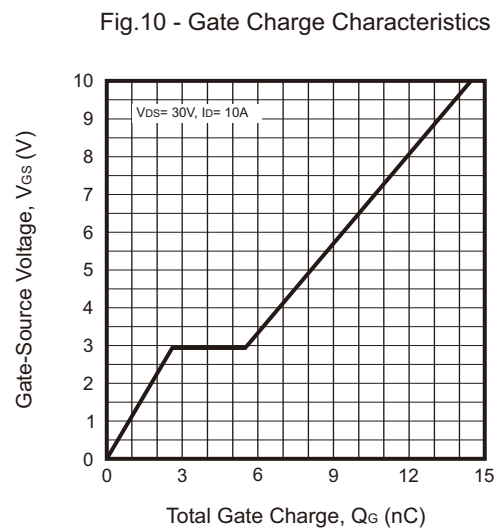
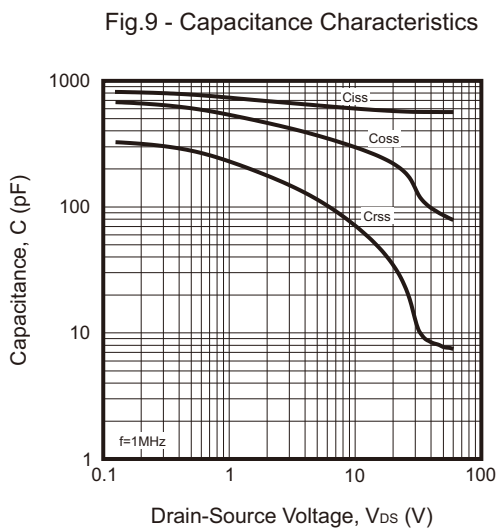
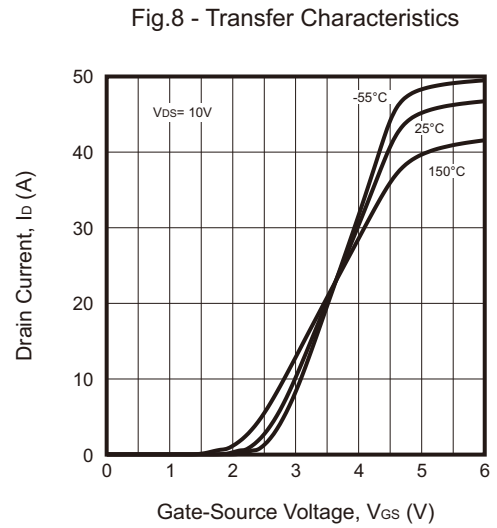
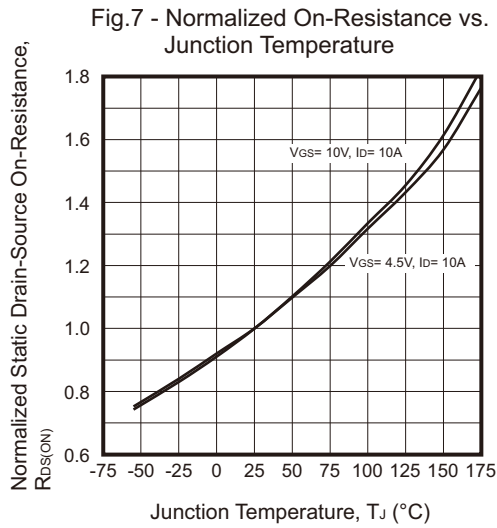

Fig.6 - Body-Diode Characteristics



Typical Rating and Characteristic Curves (CMS07N06V8-HF)



Typical Rating and Characteristic Curves (CMS07N06V8-HF)

Fig.13 - Safe Operating Area

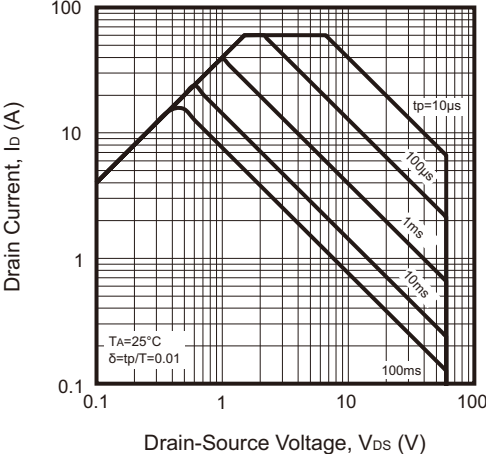

Reel Taping Specification

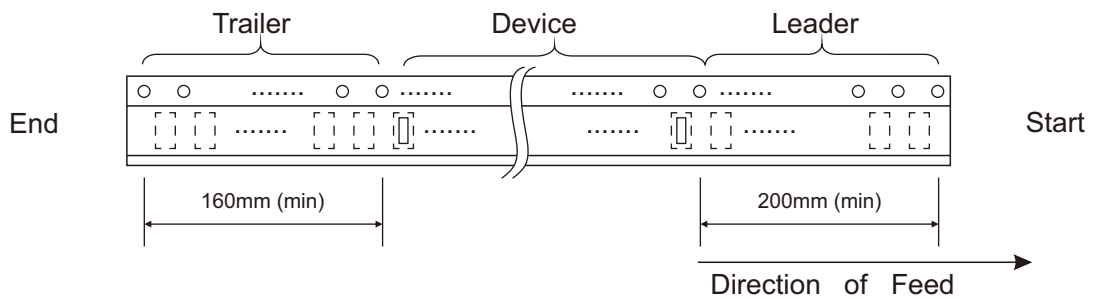
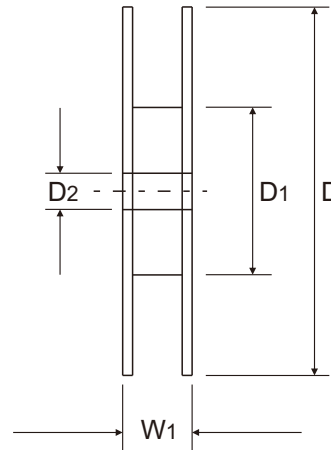
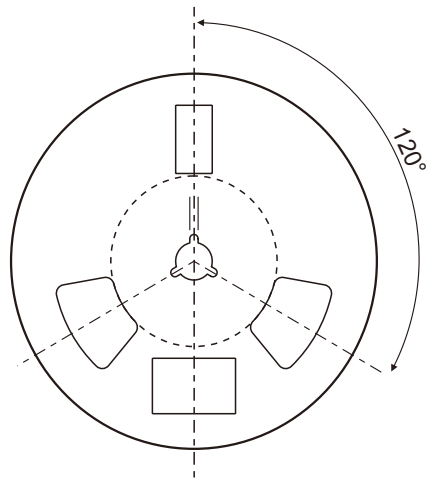
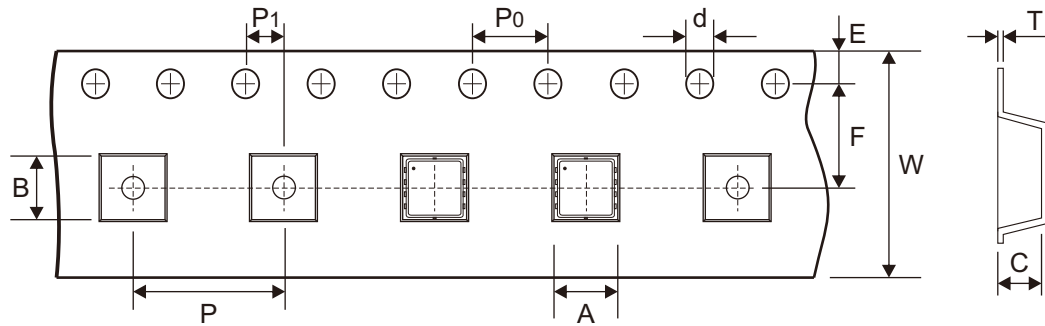

PDFN3x3-8L	SYMBOL	A	B	C	d	D	D1	D2
	(mm)	3.60 ± 0.10	3.60 ± 0.10	1.20 ± 0.10	1.50 + 0.10 - 0.00	330.00 ± 1.00	100.00 ± 1.00	13.00 ± 0.20
	(inch)	0.142 ± 0.004	0.142 ± 0.004	0.047 ± 0.004	0.059 + 0.004 - 0.000	12.992 ± 0.039	3.937 ± 0.039	0.512 ± 0.008

PDFN3x3-8L	SYMBOL	E	F	P	P0	P1	T	W	W1
	(mm)	1.75 ± 0.10	5.50 ± 0.05	8.00 ± 0.10	4.00 ± 0.10	2.00 ± 0.05	0.25 ± 0.02	12.00 + 0.30 - 0.10	17.80 ± 0.30
	(inch)	0.069 ± 0.004	0.217 ± 0.002	0.315 ± 0.004	0.157 ± 0.004	0.079 ± 0.002	0.010 ± 0.001	0.472 + 0.012 - 0.004	0.701 ± 0.012

Marking Code

Part Number	Marking Code
CMS07N06V8-HF	250N06T

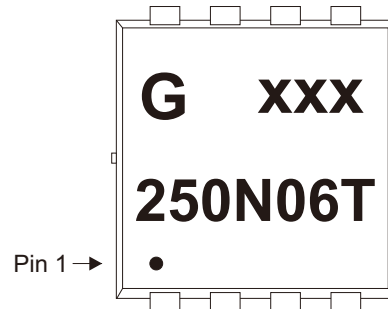

XXX = Control code

Suggested P.C.B. PAD Layout

SIZE	PDFN3x3-8L	
	(mm)	(inch)
A	0.42	0.017
B	0.70	0.028
C	0.65	0.026
D	2.25	0.089
E	2.37	0.093
F	0.42	0.017
G	0.23	0.009
H	1.85	0.073
I	3.70	0.146

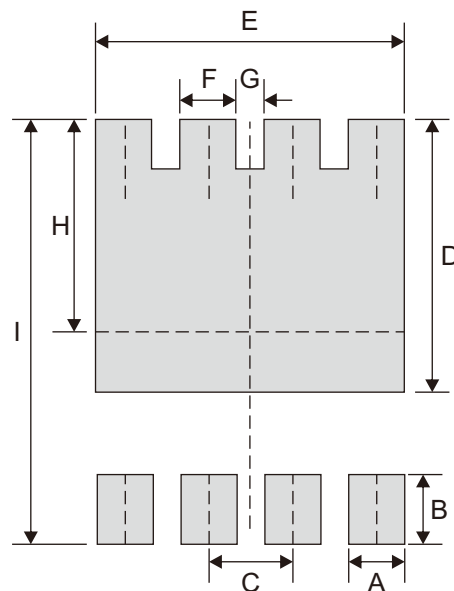

Standard Packaging

Case Type	REEL PACK	
	REEL (pcs)	Reel Size (inch)
PDFN3x3-8L	5,000	13