



Comchip Technology

Product strengths in different market segments and Diodes Application notes

Peter Liu

2009

Product Strengths – Flat Chip Switching/Schottky/Zener Diode

FLAT CHIP DIODES

★ *Thinnest*

★ *No Lead-Frame*



SOD-523F

★ *Smallest*



SOD-323F

★ *Lightest*



SOD-123F

- **RoHS Compliant Diodes:**
Flat Chip Package complies with ROHS w/o tin-whisker concerns
- **Works with RoHS and Lead-based manufacturing process:**
Copper/Nickel/Gold termination offers excellent solderability
- **High Temperature Molding Material:**
Three times oven re-flow at 260°C for 10-12 seconds
- **No Lead-Frame Diodes:**
New manufacturing process eliminates Lead-Frame for lower cost
- **Size Reduction Technology:**



	SOD-123F → SOD-323F → SOD-523F → SOD-723F
No Lead-Frame	
	SOD-123 → SOD-323 → SOD-523 → ?
Lead-Frame	
	MiniMELF → MicroMELF → ?
MELF	

www.comchiptech.com • TEL: 510-657-8671

SMD DIODES SPECIALIST



Target segments:
Portable Device,
Handheld Device, e.g.
MP3, Palm, Hearing
Aid, Hand held
scanner, or customer
looking for smaller
size package as a
replacement.

Application Notes – Flat Chip

Switching Diode

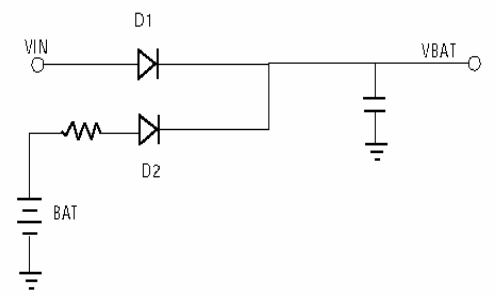
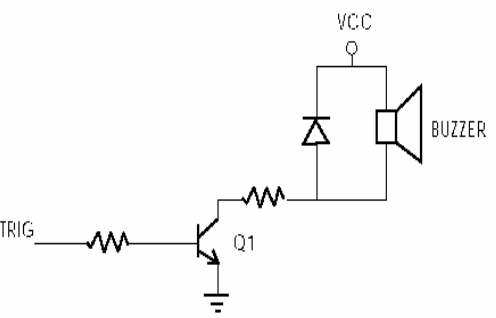
Application for Flat Chip Switching Diode	Products	Diode Selection Guide	Comchip P/N
<p>Battery Circuit for SRAM</p> 	<p>PDA, PC, Modem, TV, Telephone, Walkie-Talkie, Notebook</p>	<p>1. Low IR</p>	<p>CDSU001A CDSU4148 CDSF001A CDSF4148</p>
<p>General Buzzer Application Circuit</p> 	<p>Cellular Phone, PDA, Personal Portable Devices, Servo Motor, Pager Translator, Remote Alarm</p>	<p>1. High VR 2. High IFM</p>	<p>CDSU4148 CDSF4148 CDSN4148 CDSS4148</p>

Application Notes – Flat Chip

Switching Diodes

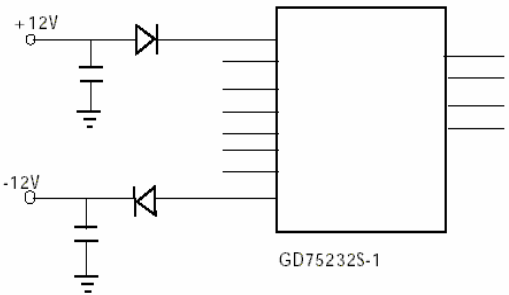
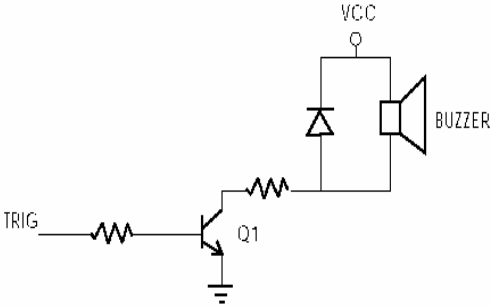
Application	Products	Diode Selection Guide	Comchip P/N
<p>Power Protection for Modem</p> 	<p>Networking equipment, RE-232, USB, Mouse, PDA, Wireless Modem, Bluetooth Module</p>	<p>1. Low VF 2. High VR</p>	<p>CDSN4148 CDSF4148 CDSU4148</p>
<p>LCD BIAS SUPPLY</p> 	<p>Cellular Phone, PDA, Digital Camera, Notebook GPS</p>	<p>1. High VR</p>	<p>CDSU4148 CDSS4148</p>

Application Notes – Switching Diode

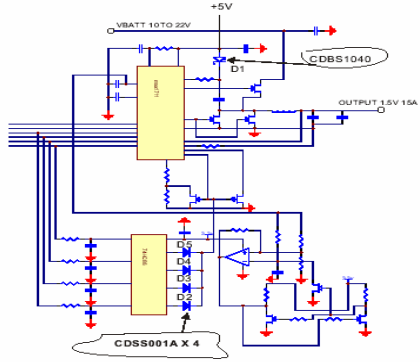







Application	Products	Diode Selection Guide	Comchip P/N
<p>Digitally Adjusted Step-Down Controllers for Notebook CPUs</p> 	<p>Notebook</p>	<p>1. Low IR</p>	<p>CDSU001A CDSU4148 CDSF4148</p>

Product Strengths – Low V_F



Super Low V_F Schottky

Comchip Technology is proud to launch the Super Low V_F Schottky diode (CDBA120SL, CDBA140SL). These are available in SMA package at 1A, 20V or 40V. With a super low V_F of 0.31V @1A, these diodes are designed to save more energy and extend battery life for today's portable electronic devices.

♦ **Low V_F Schottky**

Part Number	I_o (A)	V_R (V)	V_F (V)	Case	
CDBM120L/ 140L	1.0	20 / 40	0.38 ~ 0.40	MiniSMA	
CDBL120L/ 140L	1.0	20 / 40	0.38 ~ 0.40	DO-213AB	
CDBA120L/ 140L	1.0	20 / 40	0.40 ~ 0.38	DO-214AC	
CDBA120LL/ 140LL	1.0	20 / 40	0.37 ~ 0.34	DO-214AC	
New CDBA120SL/ 140SL	1.0	20 / 40	0.31 ~ 0.31	DO-214AC	
CDBA220L/ 240L	2.0	20 / 40	0.38 ~ 0.40	DO-214AC	
CDBA220LL/ 240LL	2.0	20 / 40	0.34 ~ 0.36	DO-214AC	
CDBA320L/ 340L	3.0	20 / 40	0.42 ~ 0.45	DO-214AC	
CDBA320LL/ 340LL	3.0	20 / 40	0.38 ~ 0.40	DO-214AC	

♦ **Small Signal Low V_F Schottky**

Part Number	I_o (mA)	V_R (V)	V_F (V)	Case	
CDBU00340	30	40	0.37	SOD-523F	
CDBU0130	100	30	0.44	SOD-523F	
CDBU0230	200	30	0.50	SOD-523F	
CDBU0240	200	40	0.55	SOD-523F	
CDBF00340	30	40	0.37	SOD-323F	
CDBF0130	100	30	0.44	SOD-323F	
CDBF0230	200	30	0.50	SOD-323F	
CDBF0240	200	40	0.55	SOD-323F	

www.comchiptech.com • TEL: 510-657-8671

SMD DIODES SPECIALIST

COMCHIP
SMD DIODE SPECIALIST

Target Market:
Portable devices to save energy and extend battery life.

Environmental friendly Green product.

Comchip has the Lowest $V_F=0.31V$ @1A in the industry.

Application Notes – Schottky Series

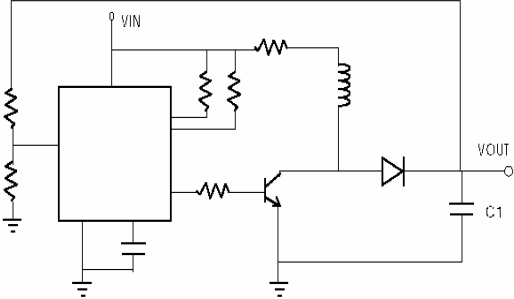
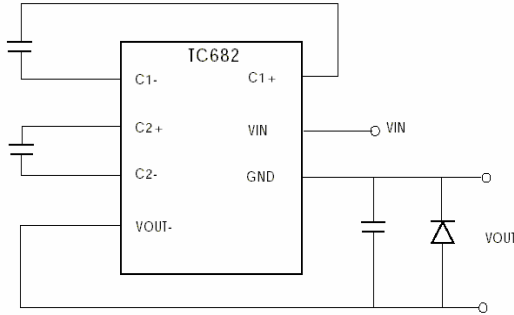
Application	Products	Diode Selection Guide	Comchip P/N
<p>Power Supply Circuit for DC to DC</p> 	<p>Telecom, Cellular Phone, PDA, Pager</p>	<ol style="list-style-type: none"> 1. Low VF 2. High VR 2. Short TRR 	<p>CDB Schottky diodes</p>
<p>Power Protection for LCD Module</p> 	<p>Cellular Phone, PDA, GPS System</p>	<ol style="list-style-type: none"> 1. Low IR 2. High VR 	<p>CDBA120-G CDBB240-G CDBC540-G</p>

Application Note – Schottky Diodes

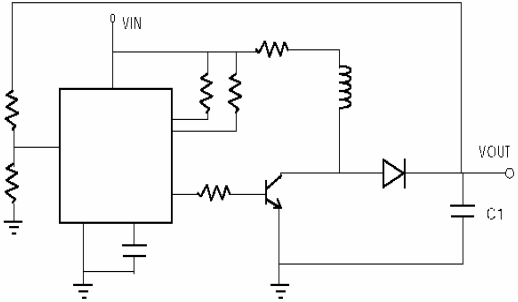
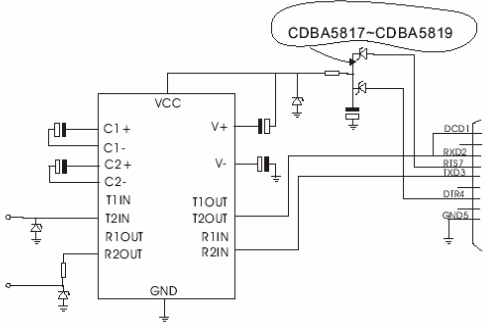
Application	Products	Diode Selection Guide	Comchip P/N
<p>USB and Keyboard Power Source</p> 	<p>PC Peripheral, USB, Keyboard</p>	<p>1. Low IR 2. Low VF 2. Short TRR</p>	<p>CDBA120-G</p>
<p>PC RS-232 with the Cell Phone Adapter</p> 	<p>Cellular Phone, PDA, PLC, Digital Camera</p>	<p>1. Low VF</p>	<p>CDBA120-G CDBA130-G CDBA140-G</p>

Application Notes – Schottky Diode

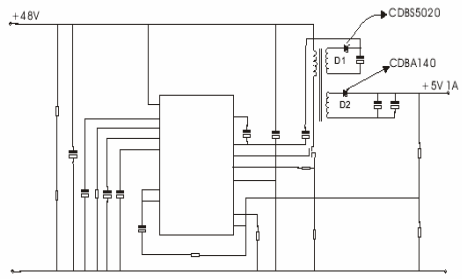
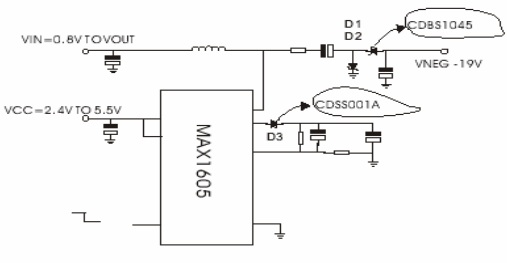
Application	Products	Diode Selection Guide	Comchip P/N
<p style="text-align: center;">High-Voltage Power-Supply Controller</p> 	<p>Modem, PLC, Telephone</p>	<p>1. Low VF</p>	<p>CDBA120-G CDBA130-G CDBA140-G CDBB240-G CDBC340-G CDBC540-G</p>
<p style="text-align: center;">LCD BIAS SUPPLY</p> 	<p>Cellular Phone, PDA, Digital Camera, Notebook, GPS</p>	<p>1. High VR</p>	<p>CDBS0140</p>

Application Notes – Schottky Diode

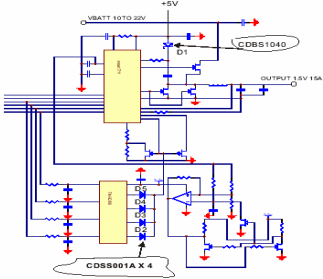
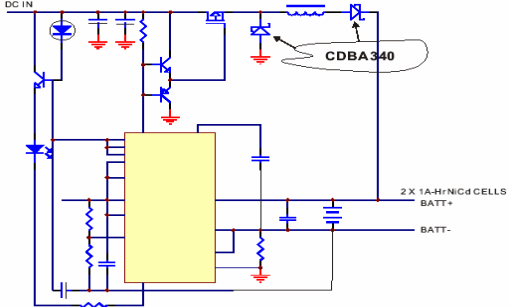
Application	Products	Diode Selection Guide	Comchip P/N
<p>Digitally Adjusted Step-Down Controllers for Notebook CPUs</p> 	<p>Notebook</p>	<p>1. Low IR</p>	<p>CDBS0140 CDBU0140</p>
<p>NiCd/NiMH Battery Fast-Charge Controllers</p> 	<p>Notebook, PDA, Cell Phone</p>	<p>1. High I_o 2. Low V_F</p>	<p>CDBA340-G</p>

Product Strengths – High Efficiency Rectifier

RECTIFIERS

HIGH EFFICIENCY

Comchip is proud to launch high quality SMD rectifiers. These high speed rectifiers provide small, light, efficient and cost-effective solutions.

- ◆ General Purpose Rectifier**
 - ▶ $V_R(V) = 20 \sim 1000$, $I_O(A) = 0.5 \sim 50$
 - ▶ Case: DO-41, DO-201AD, DO-214AC, DO-214AA, DO-213AB, DO-213AA, Mini SMA, TO-220AC
- ◆ Fast Recovery Rectifier**
 - ▶ $V_R(V) = 50 \sim 1000$, $I_O(A) = 1.0 \sim 30$, $T_{rr}(nS) = 100 \sim 500$
 - ▶ Case: DO-41, DO-214AC, DO-214AA, DO-214AB, DO-213AB, TO-213AA, ITO-220AC, TO-220AB
- ◆ Ultra Fast Recovery Rectifier**
 - ▶ $V_R(V) = 50 \sim 1000$, $I_O(A) = 1.0 \sim 30$, $T_{rr}(nS) = 50 \sim 75$
 - ▶ Case: DO-214AC, DO-214AA, DO-214AB, DO-213AB, Mini SMA, TO-220AC, TO-220AB, ITO-220AC
- ◆ Super Fast Recovery Rectifier**
 - ▶ $V_R(V) = 50 \sim 600$, $I_O(A) = 1.0 \sim 30$, $T_{rr}(nS) = 35 \sim 50$
 - ▶ Case: DO-214AC, DO-214AA, DO-214AB, DO-213AB, Mini SMA, TO-220AC, TO-220AB, ITO-220AC, ITO-220AB
- ◆ Efficient Fast Recovery Rectifier**
 - ▶ $V_R(V) = 50 \sim 600$, $I_O(A) = 1.0 \sim 10$, $T_{rr}(nS) = 25 \sim 50$
 - ▶ Case: DO-214AC, DO-214AA, DO-214AB, DO-213AB, Mini SMA, DO-41, TO-220AB

www.comchiptech.com • TEL: 510-657-8671

SMD DIODES SPECIALIST

COMCHIP
SMD DIODE SPECIALIST

Target segment:
Industrial sensors,
industrial control
board, Power supply,
GPS system, Cellular
phone.

In most of the
application, S1G or
Rectifier 4000 series
are popular
specification.

Application Note -- Rectifier

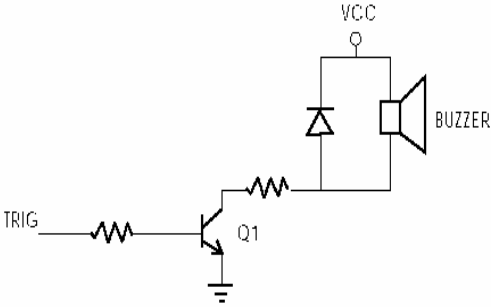
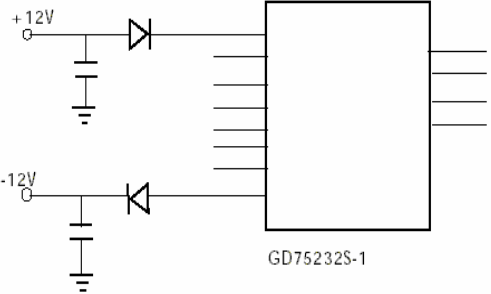
Application	Products	Diode Selection Guide	Comchip P/N
<p>General Buzzer Application Circuit</p> 	<p>Cellular Phone, PDA, Personal Portable Devices, Servo Motor, Pager Translator, Remote Alarm</p>	<p>1. High VR 2. High IFM</p>	<p>CGRA4001-G CGRA4004-G CGRA4007-G S1A-G S1G-G S1M-G</p>
<p>Power Protection for LCD Module</p> 	<p>Cellular Phone, PDA, GPS System</p>	<p>1. Low IR 2. High VR</p>	<p>CGRA4004-G</p>

Product Strengths – Bridge Rectifier

BRIDGE RECTIFIER

Comchip Technology is proud to launch high quality and cost-effective bridge rectifier, which full wave rectification from AC power source for electronic equipment. Our bridge rectifiers can meet your electronic device's power and case style requirements.

Please call 510-657-8671 for more information.



◆ Bridge Rectifiers

Part Number	V_R (V)	I_O (A)	Case
AM100-G ~ AM1010-G	50 ~ 1000	1.0	AM
AM150-G ~ AM1510-G	50 ~ 1000	1.5	AM
B05S-G ~ B10S-G	50 ~ 1000	0.5	TO-269AA
B05SGS-G ~ B10SGS-G	50 ~ 1000	0.5	TO-269AA
DF005GS-G ~ DF10S-G	50 ~ 1000	1.0	DF-S
DF005M-G ~ DF10M-G	50 ~ 1000	1.0	DF-M
DF15005S-G ~ DF1510S-G	50 ~ 1000	1.5	DF-S
HD01-G ~ HD10-G	100 ~ 1000	0.8	MINI-DIP

◆ High Power Bridge Rectifiers

Part Number	V_R (V)	I_O (A)	Case
KBPC Series	50 ~ 1000	10 ~ 50	Plastic / Terminals
KBPC-S Series	50 ~ 1000	10 ~ 50	Plastic / Single In-Line
KBPC-W Series	50 ~ 1000	10 ~ 50	Plastic / Wire Leads
MB Series	50 ~ 1000	10 ~ 50	Metal / Terminals
MB-W Series	50 ~ 1000	10 ~ 50	Metal / Wire Lead
MP1000 ~ MP1010	50 ~ 1000	10	MP-10

www.comchiptech.com • TEL: 510-657-8671

Target Market Segment:

Power Supply, Industrial Application, High Power application. Go up to $I_o=50A$

Product Strengths – ESD/TVS Diode

TVS/ESD Suppressor

Comchip TVS/ESD suppressors are designed for use in a variety of digital circuit protection applications including computer peripheral ports (IEEE1284, USB, Firewire, SCSI, gaming, video, keyboard, audio, DC power), industrial control systems, audio and networking equipments. With characteristics of low capacitance, ultra fast response time and stable breakdown, TVS/ESD suppressors have significant application advantages over metal oxide varistors. These components are RoHS compliant and offer a 16KV ESD suppression at 8/20us transient rating (IEC 61000-4-2).

◆ **ESD Suppressor**

Part Number	Channels	V _{ESD} (V)	I _{pp} (A)	Case
CPDU5V0 - 36V	1	5 - 36	5.1 - 15	SOD-523F
CPD1ESV0-G - 36V-G	1	5 - 36	5.1 - 15	0503
CKLS145V0-G - 36V-G	1	5 - 36	5.1 - 15	SOT-143
CPEV5V0-G - 36V-G	1	5 - 36	1 - 5	SOD-323

◆ **ESD Suppressor Array**

Part Number	Channels	V _{ESD} (V)	I _o (mA)	Case
CDAAQ20-G	18	10	50	QSOP-20
CDA2Q20-G	17	10	50	QSOP-20
CDA3S06-G	4	10	50	SOT23-6
CDA4S14-G	2	13	50	SOT-143
CDA8N08-G	6	13	50	NSOIC-8
CDA7Q24-G	18	13	50	QSOP-24
CDA8S03-G	1	10	50	SOT-23
CDA9N08-G	4	10	50	NSOIC-8

◆ **ESD Suppressor Array**

Part Number	Channels	V _{ESD} (V)	I _{pp} (A)	Case
CEAS035V0-G - 36V-G	2	5 - 36	5.1 - 15	SOT23-3
CEBS035V0-G - 36V-G	4	5 - 36	5.1 - 15	SOT23-6
CECS035V0-G - 36V-G	5	5 - 36	5.1 - 15	SOT23-6
CEDS035V0-G - 36V-G	4	5 - 36	5.1 - 15	SOT23-5
CEGS035V0-G - 36V-G	1	5 - 36	5.1 - 15	SOT-143
CEEN085V0-G - 24V-G	4	5 - 24	5.1 - 15	NSOIC-8
CEEN145V0-G - 24V-G	7	5 - 24	5.1 - 15	NSOIC-14
CEEN165V0-G - 24V-G	8	5 - 24	5.1 - 15	NSOIC-16
CEEQ165V0-G - 24V-G	8	5 - 24	5.1 - 15	QSOP-16
CEEW185V0-G - 24V-G	8	5 - 24	5.1 - 15	WSOIC-16
CEEW205V0-G - 24V-G	10	5 - 24	5.1 - 15	WSOIC-20
CEFN085V0-G - 24V-G	7	5 - 24	5.1 - 15	NSOIC-8
CEFN145V0-G - 24V-G	13	5 - 24	5.1 - 15	NSOIC-14
CEFN165V0-G - 24V-G	15	5 - 24	5.1 - 15	NSOIC-16
CEFQ165V0-G - 24V-G	15	5 - 24	5.1 - 15	QSOP-16
CEFW165V0-G - 24V-G	15	5 - 24	5.1 - 15	WSOIC-16
CEFW205V0-G - 24V-G	19	5 - 24	5.1 - 15	WSOIC-20

◆ **TVS Array**

Part Number	P _{ppm} (Watts)	V _R (V)	Case
CTAN145V0-G - 36V-G	300	5 - 36	SOIC-14
CTBN145V0-G - 36V-G	300	5 - 36	SOIC-8
CTCN145V0-G - 36V-G	300	5 - 36	SOIC-8
CTDN145V0-G - 36V-G	300	5 - 36	SOT-623
CTEN145V0-G - 36V-G	300	5 - 36	SOT-23

www.comchiptech.com • TEL: 510-657-8671

Target Market:

High speed digital circuitry applications including cellular handsets and accessories, portable products, audio and visual equipment, protection for I/O ports, networking systems, high-speed data lines and computer components.

TVS Diodes Application Guide

TELECOM			
Application	Applicable Comchip PN		
CATV Set-Top Box	P6KE200		
Cable Modem	SMBJ14CA	SMCJ5.0A	
Cellular Phone	SMAJ20C		
Commercial Telecom Multiplexer	SMBJ170CA		
DSS (Direct Satellite System)	P6KE91A	SMBJ150A	
DSS Receiver	1.5KE18CA	SMBJ170A	
Digital ISDN Telecom Network	SMCJ5.0A		
GSM Phone [1]	SMAJ5.0A	SMBJ9.0A	SMBJ16A
Military Radio Controller	P6KE18CA		
Personal Handy-Phone System (PHS) [3]	P6KE91	SMBJ78	
Router	P6KE91	SMBJ75A	
Satellite Antenna	SMCJ20A		
Satellite Dish System	SMCJ20A	SMCJ24A	
Satellite Receiver	1.5KE27A	SMCJ24A	
Telecom Switching System	1.5KE62A	SMCJ58A	

TVS Diodes Application Guide

CONSUMER			
Application	Applicable Comchip PN		
Air Conditioner	1.5KE220A		
Audio Op-Amp Output Protection Circuit	LCE26A	LCE28A	
Color TV (21")	P4KE120		
DVD (Digital Video Disk) Player	1.5KE180A	P6KE120	
Emergency Lighting	P6KE440CA		
Flight Simulator	SMCJ36CA	SMCJ170CA	
HDTV	1.5KE200A		
Home Security System	SA5.0A	SA11CA	SMBJ12A
MP3 Player	SMBJ22A		
Security Camera System	LCE7.0	SAC7.0	
Smoke Detector	P6KE20CA	SMBJ40CA	SMBJ43A
TGV ABS System	1.5KE160CA		
Vending Machine	SMAJ15		
Video Camera	P6KE180A		

TVS Diodes Application Guide

COMPUTER		
Application	Applicable Comchip PN	
Desktop PC	P4KE6.8A	SA5.0A
Disk Drive	SMBJ5.0A	
HDD (Hard Disk Drive)	P6KE22	SMBJ5.0A
Laser Printer	P4KE200	P4KE250
Local Area Network (LAN) Board	SMBJ15C	
Modem Card	P6KE120CA	SMBJ110CA
Motherboard	P6KE400A	
Printer	SMAJ5.0	
UPS	1.5KE300A	1.5KE6.8A

TVS Diodes Application Guide

INDUSTRIAL				
Application	Applicable Comchip PN			
Aircraft Engine Controller	SMCJ13			
Aircraft Onboard Electronics System	SMBJ33CA			
Aircraft Sensor TVS Protection Circuitry	SMCJ13A	SMCJ24A	SMCJ28A	SMCJ33CA
Airplane "Black Box" Data Recorder System	SMCJ6.5CA	SMCJ40CA		
Airplane Lightning Protection Equipment	LCE7.5A	SAC5.0		
Card Reader	SMBJ5.0	SMCJ15CA		
Control Equipment	SMAJ15C			
Elevator	1.5KE440A			
Fire Alarm System	SA14			
Gas Alarm	SMAJ5.0	SMAJ170		
Image Inspection System	SMBJ5.0A	SMBJ15A		
Nuclear Test Box	SA45CA	SA51CA		
Power MOSFET protection (P6KE36A)	P6KE36A			
Submarine	1.5KE350A			
Voltage Regulator	1.5KE20A	5KP20A		

TVS Diodes Application Guide

AUTOMOTIVE			
Application	Applicable Comchip PN		
Adjustable Pedal Module (APM)	SMBJ26A		
Airbag	5KP24A		
Airbag Crash Sensor Module	SMBJ24CA		
Alarm System	P6KE27A	SMBJ24A	
Electronic Ignition Module	P4KE300A		
Engine Control	1.5KE13A	5KP24	SMCJ13A
Load Dump Circuit [8]	5KP43A	P6KE68A	
Mass Air Flow Regulator	SMAJ24C		
Oxygen Sensor	SMAJ15A		
Power Window Control Module	P6KE51A	SMBJ45A	
Speed Control Module	1.5KA24A	SMCJ22A	
Steering Controller	5KP28A		
Truck Transmission Controller	SMAJ30C		

TVS Diodes Application Guide

POWER SUPPLY					
Application	Applicable Comchip PN				
AC/DC Converter	SMBJ5.0A				
3.3V SMPS Output	SMBJ20A				
Bank ATM Machine Power Supply	1.5KE51A	SMCJ45A			
High Power SMPS	P6KE160	SMBJ130			
Lightning Suppression Board	5KP51	5KP51A	5KP78	5KP78 A	
Switching power supply	P6KE200A				
Transient Suppression Circuit	1.5KE220CA	5KP5.0A	5KP12A	5KP15 A	5KP2 4A

TVS Diodes Application Guide

LIGHTING BALLAST	
Application	Applicable Comchip PN
Active Power Factor Correction Ballast	P6KE220A
Control Circuitry	P4KE440CA
Electronic Ballast (EB)	P6KE400
Electronic Dimmer Ballast	P4KE440A
Electronic Lighting Ballast	1.5KE300A
Fluorescent Ballast	P6KE300